



# UHF

**40W**

***Wireless Portable Sound System***



O  
GPA-670 (Lithium battery powered)

**[ User Manual ]**

## Illustration



1. Tweeter (1")
2. Neodymium driver (5")
3. Receiver DR-50
4. Digital audio player UM-502

5. Controls, battery meter, mic in
6. Power switch
7. DC input
8. Battery door

## Battery replacement



Get screws off



Take battery out



Get connection right –  
RED for Anode;  
BLACK for Cathode



Carry Bag  
CB-650



Folding Tripod  
ST-35

# Controls and Operation

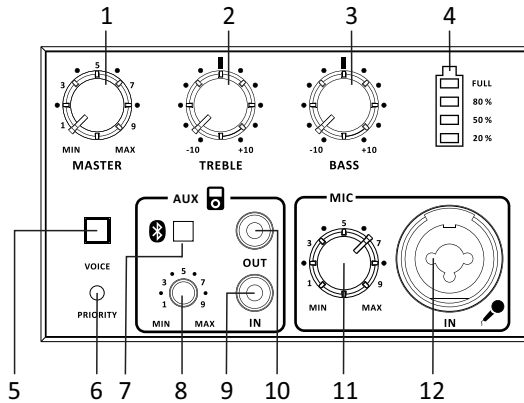

1. Master
2. Treble
3. Bass
4. Battery meter
5. Voice priority: when activated, an indicator (6) will light up
6. Voice priority indicator
7. Bluetooth
8. Bluetooth control
9. AUX in (3.5mm)
10. AUX out (3.5mm)
11. Mic (wired) in control
12. Mic in (XLR/6.3mm) stereo

# Wireless Receiver Module DR-500

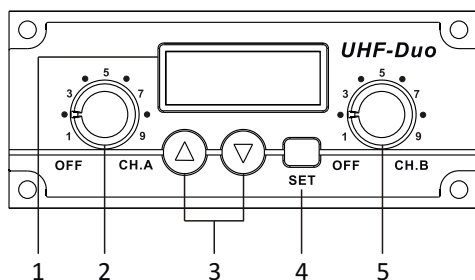

1. LCD Window  
(Display Channel Number /  
Reception Strength)
2. Channel A  
Power Switch and Volume Control
3. Up / Down Frequency Selector
4. Frequency Set Key
5. Channel B  
Power Switch and Volume Control

## Operation and Setting

### Switch on/Switch off

1. Turn “Channel A / B” knob (2) / (5) clockwise until a click occurs, then LCD window will be on and a text of “On” will appear on LCD window. After 1 ~ 2 seconds, the LCD window will show a channel number and signal strength, it means the receiver module switched-on successfully.
2. Vice versa, turn “Channel A / B” knob (2) / (5) counterclockwise until a click occurs, then LCD window will show a text of “OFF” for about 2 ~ 3 seconds. LCD window will be off after this procedure, switched-off successfully.

### Setting and Selection of Channels



Press and hold “SET” key (4) to enter the mode of selecting the channels

1. While both Channel A and Channel B are available, the channel number of Channel A shown on LCD window starts to blink. Press “Up” or “Down” Frequency Selector keys (3) to look for your preferred channel number. Press “SET” key (4) again to confirm the channel setting.
2. While only Channel A or Channel B is available, switch the channel number of Channel A or Channel B directly.
3. If you don't press any key for more than 10 seconds, it will leave the channel-switching mode with channel number kept.
4. Channel A and Channel B cannot be set with the same channel number.



### Searching for Available Channels

1. Press “Up” and “Down” Frequency Selector keys (3) simultaneously for more than 1 second, and then LCD window will show a text of **SCAN** without blinking. Channel A and Channel B will be switched to available channels automatically. If there is no any channel available, the channel numbers will still remain the same.

## Wireless Receiver Module DR-500

2. Press “Up” Frequency Selector key (3) for more than 1 second, and then LCD window will show  , Channel A would be switched to available channel automatically. If there is no channel available, the channel value would be kept the same.
3. Press “Down” Frequency Selector key (3) for more than 1 second, and then LCD window will show  , Channel B would be switched to available channel automatically. If there is no channel available, the channel value would be kept the same.
4. Using two DR-500 wireless receiver modules simultaneously:
  - Press “Up” and “Down” Frequency Selector keys (3) simultaneously on DR-500 module 1 for more than 1 second, you could find two available channels.
  - Switch on two Transmitters used for Wireless Receiver Module 1 and adjust the channel number accordingly.
  - Press “Up” Frequency Selector key (3) on Wireless Receiver Module 2 for more than 1 second, you could find available channel for Channel A.
  - Switch on the third Transmitter used for Wireless Receiver Module 2 and adjust the channel number accordingly.
  - Press “Down” Frequency Selector key (3) on Wireless Receiver Module 2 for more than 1 second, you could find available channel for Channel B.
  - Switch on the fourth Transmitter. Finalize the process of four channels used simultaneously.

### Setting of Group Number and SQ Value

1. Press “Set” key (4) and then switch on Channel A or Channel B to enter Group setting, and then LCD window would show  (number will keep blinking).
2. Press “Up” or “Down” Frequency Selector keys (3) to look for your preferred group number.
3. Press “SET” key (4) to confirm the group setting or wait for 5 seconds to confirm it automatically and then enter setting mode of SQ value.
4. Under setting mode of SQ value, LCD window will show  (number will keep blinking).
5. Press “Up” or “Down” Frequency Selector keys (3) to choose SQ value, the value will not be set in circulation.
6. Press “SET” key (4) again to confirm the group setting or wait for 5 seconds to confirm it automatically and then back to normal switching-on mode.

### CAUTION!

- Please keep the distance between the Transmitter and the Receiver more than 2 M.
- Please keep the distance between the Transmitter and the Transmitter more than 0.5 M.

# Wireless Bodypack Transmitter EJ-7XT+

1. Antenna
2. Mute Control
3. Power Switch
4. 3.5 mm push-in (EJ-7T+) or Mini-XLR (EJ-7XT+) Microphone Input
5. LED Power Indicator
6. Sensitivity Selection
7. AUX In (3.5 mm)
8. Frequency Set
9. LCD Window
10. Turn Up / Down Frequencies Keys
11. Recharge Jack

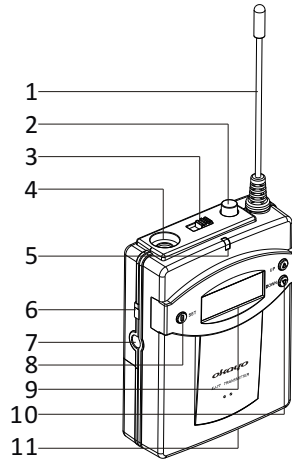

## Operation and Setting

### Turn-on

Turn on the “Power Switch” (3), the LCD window will show “On” and the Backlight & “LED Power Indicator” (5) will be light on. After 1 second, the LCD window will show channel number and battery life indicator.

### Turn-off

Turn off the “Power Switch” (3), the LCD window will show “OFF” with backlight on, and then turn off.

### Setting of Channel

After turning on the unit, the current channel **CH01** is shown on the LCD window. Press “Frequency Set” key (8) for 2 seconds to until the channel number starts to blink, and then press “Up” or “Down” key (10) to select the channel from 1-96. Press “Frequency Set” key (8) again to confirm the setting of channel or it will return back to the original channel number after 10 seconds without pressing “Frequency Set” key (8).

※The transmitter and the receiver should be set on the same channel.

### Display of Channel

Press “Up” or “Down” key (10) or press “Up” and “Down” keys (10) simultaneously to show current frequency value on the LCD window. The LCD window will go back to normal after releasing fingers from keys.

# Wireless Bodypack Transmitter EJ-7XT+

## Inserting batteries



1. Remove the cover.
2. Replace with 2 1.5V AA/LR6 Alkaline batteries or 2 1.2V AA/LR6 chargeable NiMH batteries(max 2100 mAh).
3. Replace the cover.

**Note: Take out batteries when the device won't be operating in a long time.**

## Information in LCD display



1. Channel 8 is set and battery status full.



2. Batteries are running out and should be replaced.



3. When indicator is blinking the batteries are almost finished. When the batteries are completely empty, the device turns off.

Note that poorly charged batteries may impair system performance.

The batteries are charged in Okayo charging stations. Use only original chargers.

**NOTE!** Use only rechargeable batteries if you use a charging station (NiMH, max 2100 mAh). Alkaline will lead to battery leakage or even explosion!

## Microphone sensitivity

**Warning!** Make sure that the noise level does not get too high in the receiver that is used with headphones.

Connect the selected microphone to the pocket transmitter and set the sensitivity with the controller on the left side of the receiver: HI / MID / LOW.

For conference seating with pressure zone microphones, sensitivity HI is recommended for optimal speech intelligibility. For use with headset microphones, sensitivity is MID recommended (we recommend the headset microphone HM-50C).

**NOTE!** EJ-701TM+ has less sensitivity than EJ-7XT+. If the pocket transmitter is used in a facility together with handheld microphones, the sensitivity should be set to Low.



# Wireless Handheld Mic EJ-701TM+

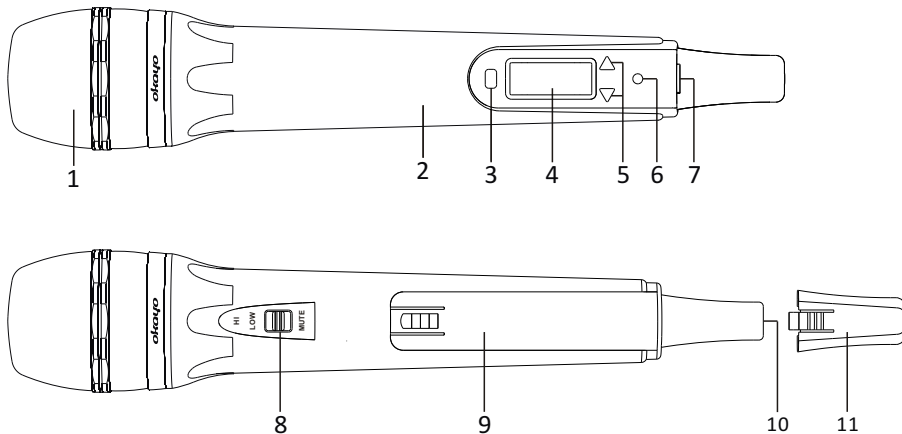

1. Mesh head
2. Handheld tube
3. Setup button
4. LCD window  
(channel, frequency, battery energy)
5. Up / Down button
6. Power indicator
7. Power ON / OFF button
8. HI / Low / Mute  
sensitivity selector
9. Battery door
10. Charging port
11. Button cap

## Put Batteries in Microphone



1. Take off button cap (11) and pull off battery door (9).
2. Insert batteries correctly. (two AA 1.2 V Ni-MH rechargeable batteries or 1.5 V Alkaline batteries) Put the button cap (11) back.
3. This action ensures the battery door is locked and to prevent from falling off. Insert 2 pcs of 1.5 V AA alkaline batteries or 1.2 V AA rechargeable batteries into the battery case, and then close the battery door (9) tightly

### CAUTION !

※ **DO NOT use larger capacity battery.**  
(e.g. the Ni-MH battery with over 2300 mAh might be stuck in battery room and can't be taken out!)

# Wireless Handheld Mic EJ-701TM+

## Operation and Setting

### Turn-on / Turn-off

1. Press “Power Switch” key (7) for 1 second to turn on the unit. The LCD window will show “On” first and then show channel number and battery life indicator after 1~2 seconds. The LED Power Indicator will be light on in blue as well.
2. Under any situation, the unit can be turned off if pressing “Power Switch” key (7) for more than 2 seconds.

### Setting of Channel

After turning on the unit, the current channel **CH.01** is shown on the LCD window. Press “Frequency Set” key (3) for more than 2 seconds until the channel number **CH.01** starts to blink, and then press “Up” or “Down” key (5) to select the channel from 1-96. Press “Frequency Set” key (3) again to confirm the setting of channel number or it will return back to the original channel number after 10 seconds without pressing any key.

- ※ The performance of signal transmission is highly involved with battery energy. Batteries with 00 mAh (or above) in capacity are recommended. The optional charger HDC-702 is an economy solution for you daily use.

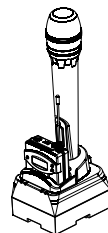

HDC-702

### CAUTION!!

- ※ **DO NOT attempt to charge Alkaline battery. It will lead to battery leakage or even explosion!**
- ※ **Take out batteries when the devices won't be operated in a long time.**

## Important Notes

### Avoiding heat and humidity

- Keep the device away from any heat source and in a location with good ventilation. Do not leave it under sunlight or close to heater.
- DON'T operate the device in the rain or in humid circumstance to prevent failure.
- Prevent the device from dropping.
- Apply factory recommended power supply to this system only. It is dangerous and risky when employing a unqualified power.

### Replacing batteries

- Make sure the substitute batteries are with same specifications.
- Using incorrect batteries might lead to explosion or malfunction.

**Remove battery from transmitter when you won't use it for a long while.**

### Charging contacts

- Clean charging contacts regularly to ensure good connection with charger. When any corrosion occurs, contact your dealer to change it if you can't repair it.

## Troubleshooting

### Failed to Power On

- Be sure batteries are allocated and put in correct direction.
- Be sure power adapter is plugged well.

### No Sound Output

- Be sure volume control on transmitter and receiver are turned properly.
- Be sure Mute button is not on.
- Be sure transmitter and receiver stay at same channel.
- Check if there is huge air interference nearby.

### Acoustic feedback is overlarge

- Adjust the volume of microphone and receiver module properly.

### Failing to charge

- Make sure the charger is connected with power supply correctly.
- Make sure battery contacts are clean and free of corrosion.
- Change batteries if the device still can't be charged.

# Specifications

## Wireless Bodypack Transmitter EJ-7T+/EJ-7XT+

Transmitter	EJ-7T+	EJ-7XT+
Input jack	3.5 mm push-in	Mini-XLR Microphone Input
Microphone capsule	Condenser	
Antenna	Flexible antenna	
RF output	10 mW	
Spurious emission	Less than 250 nW	
Audio input	Ø3.5 mm Mic in, Aux in	
AF controls	Mute switch, Hi / Mid / Low switch	
Power requirements	2 x 1.2 V (Ni-MH 00 mAh) AA type rechargeable batteries	
	2 x 1.5 V AA Alkaline disposable batteries	
Power supply	8 hours typical in Ni-MH rechargeable batteries	
	14 hours typical in Alkaline disposable	
Dimensions (DxWxH)	26 x 64 x 88 mm	
Weight	170 g (battery included)	

## Wireless Handheld Mic EJ-701TS+ / EJ-701TM+

Microphone	EJ-701TS+	EJ-701TM+
Microphone capsule	Dynamic capsule	Condenser capsule
Antenna	Built-in antenna	
RF output	10 mW	
Spurious emission	Less than 250 nW	
AF controls	Hi / Low / Mute switch	
Power requirements	2 x 1.2 V (Ni-MH 00 mAh) AA type rechargeable batteries	
	2 x 1.5 V AA Alkaline disposable batteries	
Power supply	8 hours typical in Ni-HM rechargeable batteries	
	14 hours typical in Alkaline disposable	
Dimensions (ØxL)	26 (dia.) x 264 mm	
Weight	237 g (battery included)	

# Digital Audio Player UM-502

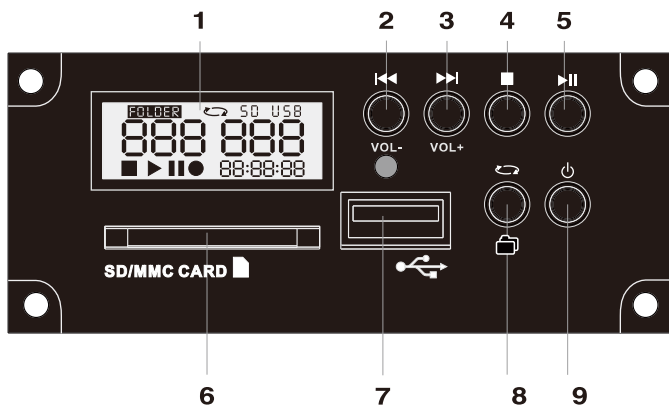

1. LCD window
2. Previous track / volume down  
(works during playback)
3. Next track / volume up  
(works during playback)
4. Stop
5. Play / Pause
6. SD/MMC port
7. USB port
8. Repeat / Folder select
9. Power
10. Volume down (MUTE when in minimum level)
11. Volume up
12. Mute
13. Folder select

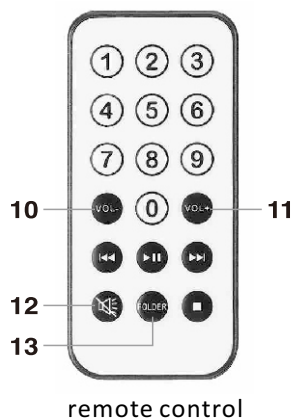



remote control

1. Press and hold (9) for 1 second to turn this player on. Press and hold (9) for 1 second to turn it off.
2. Press (2) to play previous audio track; press (3) to play next audio track. Press (4) to stop any playback.
3. Press (5) to Play or to Pause any audio track.
4. When both SD card and USB are installed, USB has higher priority to be readout.
5. Do not pull SD card out directly or it might be damaged. Just push it a bit forward and it will be ejected.

## Digital Audio Player UM-502

### 6. Repeat / Folder Select:

a. There are 3 modes for repeat during audio playback.

-  : To repeat a track.
-  : To repeat all tracks in all album.
-  : To repeat all tracks in a single album.

b. When not in playback, press (8) to select a desired folder/album with NEXT, PREV buttons. Finally press PLAY to end the setting.

7. During playback, press VOL+ to increase volume; press VOL- to decrease volume.

# Troubleshooting

## **Failed to Power On**

Be sure batteries are allocated and put in correct direction.  
Be sure power adapter is plugged well.

## **No Sound Output**

Be sure transmitter and receiver stay at same channel.  
Be sure volume control on transmitter and receiver are turned properly.  
Be sure Master is turned properly.  
Be sure Mute button is not on.  
Check if transmitter and receiver stay at same frequency band.  
Check if there is huge air interference nearby.

# Maintenance

## Avoid heat, humidity

DO NOT put the unit in the sunshine for a long time, or any other hot, humid environments or places with flame. Stay away from any occasions where situation mentioned above might occur. Store the unit in general indoor temperature or in cool circumstance.

## Charge BEFORE you start using for the first time

After unpacking the unit for the first time, please charge the unit for about 8 hours. This is absolutely necessary as the built-in rechargeable battery might have been discharged naturally due to long transportation and storage time, even though it has been fully charged in the factory prior to shipment. To secure a longer life for battery, please MUST execute this IMPORTANT process.

## Charge fully

Ensure battery is fully charged BEFORE you store the unit. To remain a longer battery life and better performance, make sure you charge the battery regularly every month.

👉 **When you need to use the unit again after a long period of storage, make sure you charge it fully for at least 8 hours BEFORE any operation.**

👉 **Please also charge this unit every time right after operation to secure a longer battery life.**

This unit has DOD (depth of discharge) protection design. When Power Switch LED flashes red - which means there isn't enough electricity (when operating via the battery's power - this unit will turn off automatically in a short time to secure battery from deep-discharging damage. At this moment please immediately recharge your unit, do not continue with operation.

This unit has protection circuit against overcharge. The circuit will stop charging when battery is fully charged even power cord is plugged.

**Useful hint: You can still operate during charging.**

## Replacing battery

Make sure the substitute battery is in compliance with qualified specifications. Using incorrect battery may lead to explosion or malfunction.



## Maintenance

**Remove battery from transmitter when you won't use it for a long while.**

### **Charging contacts**

Clean charging contacts regularly to ensure good connection with charger. When any corrosion occurs, contact your dealer to change it if you can't repair it.

This device complies with Part 15 of the FCC Rules. Operation is subject to the following two conditions: (1) this device may not cause harmful interference, and (2) this device must accept any interference received, including interference that may cause undesired operation.

Notice: The changes or modifications not expressly approved by the party responsible for compliance could void the user's authority to operate the equipment.

NOTE: This equipment has been tested and found to comply with the limits for a Class B digital device, pursuant to part 15 of the FCC Rules. These limits are designed to provide reasonable protection against harmful interference in a residential installation.

This equipment generates, uses and can radiate radio frequency energy and, if not installed and used in accordance with the instructions, may cause harmful interference to radio communications. However, there is no guarantee that interference will not occur in a particular installation.

If this equipment does cause harmful interference to radio or television reception, which can be determined by turning the equipment off and on, the user is encouraged to try to correct the interference by one or more of the following measures:

- Reorient or relocate the receiving antenna.
- Increase the separation between the equipment and receiver.
- Connect the equipment into an outlet on a circuit different from that to which the receiver is connected.
- Consult the dealer or an experienced radio/ TV technician for help.

# Specifications

## Overall

Carrier frequency	640 ~ 865 MHz (country dependant)
Channels	16 ~ 96 (frequency dependant)
LCD window	channel, frequency
Channel adjustment	select through UP and DOWN
Frequency modulation	24 MHz (max.)
Ambient temperature	-10 °C ~ +50 °C
Dynamic range	100 dB
T.H.D.	< 0.5 %
Pre-emphasis	50 $\mu$ s
Frequency response	70 Hz ~ 16 kHz
Wireless coverage	25 ~ 50 meter (RF power dependant)

Output power	40 W (RMS) @ 4 $\Omega$
Speaker	5" Neo driver, 1" tweeter
Digital audio player	supports USB disk and SD card (optional)
Receiver	plug-in receiver with ACS (Auto Channel Synchronization), supports 2 receivers maximum.
Audio input	mic in (combo jack); aux in (stereo mixed, 3.5 mm)
Audio output	aux out (stereo mixed, 3.5 mm)
Controls	Master, Tone, Mic, Aux in
Power supply	AC switching power adapter 100 ~ 240 V, 20V/3.25A
Battery	Lead-Acid, Ni-MH, Lithium rechargeable battery (model dependant)
Charging time	8 ~ 12 hours (battery dependant)
Running time	3 ~ 6 hours (battery dependant)
Dimensions (DxWxH)	200 x 170 x 276 mm
Weight	3.7 kg (Lithium battery included)

※ Specifications are subject to change



Edited by Bo Edin AB 2017



**OKAYO ELECTRONICS CO., LTD.**

No. 2, Gongye 10<sup>th</sup> Rd., Dali Dist., Taichung 41280, Taiwan

Tel:+886-4-2491-4666 Fax:+886-4-2491-3066

E-mail:[okayo@okayo.com](mailto:okayo@okayo.com)

[www.okayo.com](http://www.okayo.com)