

IDEE PROGETTI SOLUZIONI

FULGOR SERVICE

"Sound diffusion in large rooms has always been one of the biggest problems for those working in the electro -acoustic sector ; phenomena of reflection , diffraction and refraction of both omnidirectional and unidirectional types with long sound propagation times results in poor levels of intelligibility ; with our latest linear speaker array designs and digital technologies we continually strive to overcome these challenges , optimising speech intelligibility, whilst maintaining the richness of reproduced sound "

Fulgor Service is an Italian company established over thirty years ago by three partners who had been working in the liturgical sector since the seventies. The company specialises in the design and manufacture of audio systems from the simple to advanced, producing audio equipment to maximum the intelligibility of the spoken word in every environment regardless of the acoustic challenges.

The product range is diverse: active loudspeakers, high efficiency passive loudspeakers, array speakers with digital directivity control, programmable digital computer platforms, wireless array loudspeakers, advanced radio systems and a wide range of installation accessories.

All products carrying the Fulgor Service brand are designed and built in Italy to the highest quality standards and subject to a vigorous quality control system to ensure build standards, performance and reliability are maintained.



This "magazine" has been translated by Univox Audio Ltd. It is intend to provide the reader with an overview of just some of the recent projects incorporating equipment designed and manufactured by Fugor services. Univox AudioLtd apologies for any errors in translation but does not accept any liability.

Santa Caterina - Basilica of the Nativity - Bethlehem



FULGOR SERVICE

The Basilica where it all began!

Fulgor Service had the honor of creating the audio system for this Basilica.

Many different religious functions are carried out both inside and outside the Basilica including Christian processions that pass through the Orthodox section.

Fulgor Service used their own digital audio equipment; mixers, amplifiers, switching matrix and control panels and high efficiency RAE speakers to provide the high fidelity, intelligible sound demanded in this environmentally and acoustically challenging location

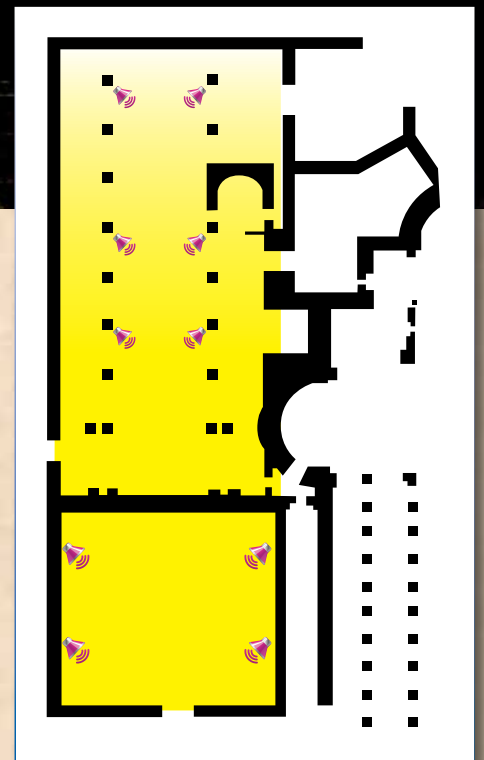

Church of the Transfiguration - Monte Tabor - Galilea



FULGOR SERVICE

Sanctuary of Gethsemani - Jerusalem - Israel



The client wanted the same results here as we had achieved in the Basilica of the Nativity in Bethlehem. Not only did they want the same clarity of sound and speech intelligibility they also insisted that the control interface was the same.

As can be seen from the photos and floor plans, the structures are completely different, but with the versatility of our sound technology it was no problem to obtain the same excellent result.

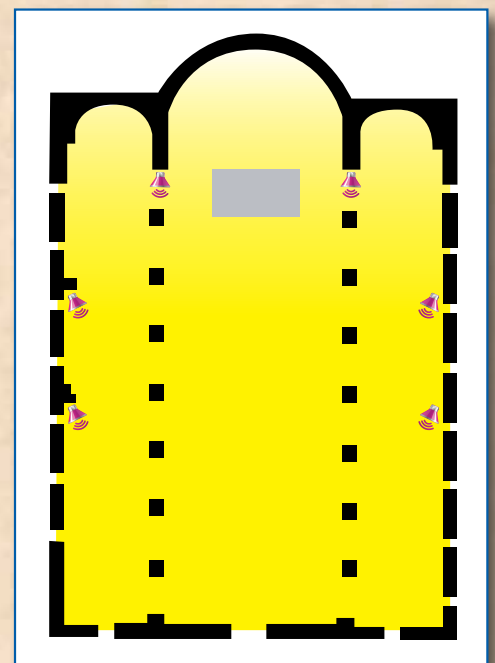

Basilica St. Francesco d'Assisi -Assisi - (Pg)

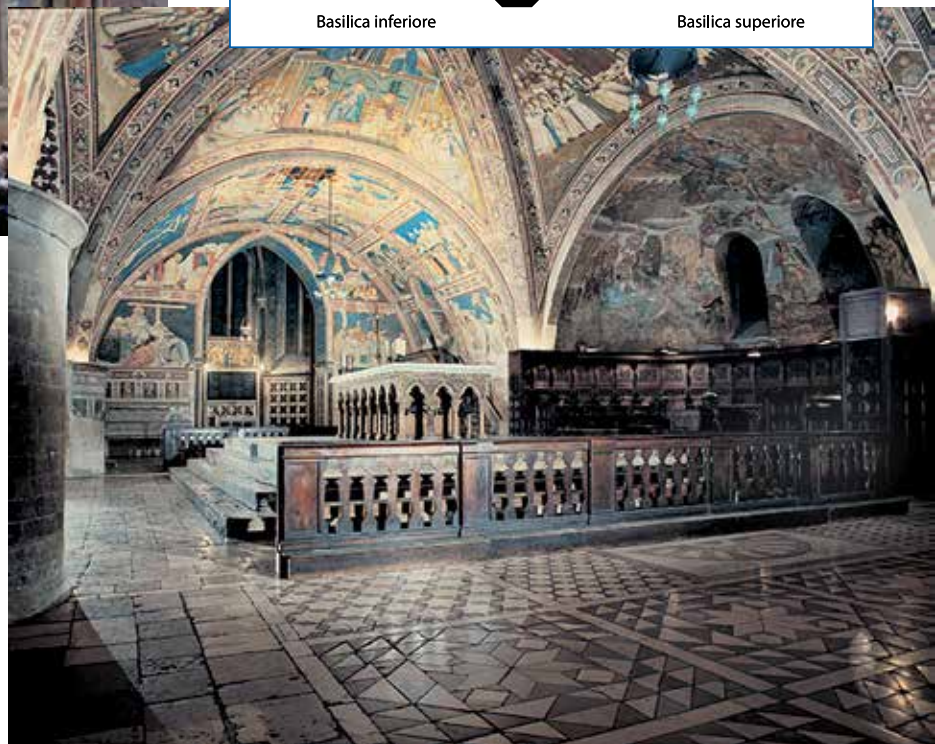
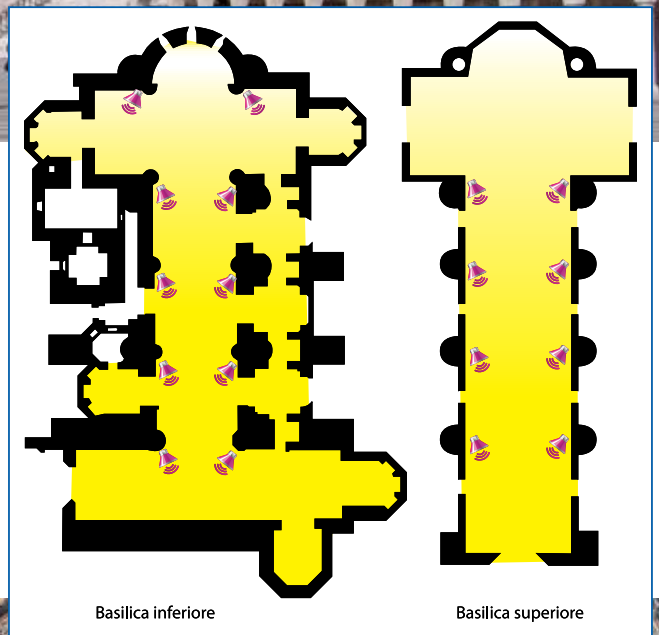

Convent Refectory



The convent refectory is 65 meters long, 12 meters wide and 14 meters high. 'Directivity DMax' a digital audio systems with sound directivity was used with only 2 loudspeakers to provide unprecedented speech intelligibility throughout the entire space

Directivity

Press Room Sacred Convent



Directivity

'DIRECTIVITY', a Digital Audio system with controlled directivity guarantees the clarity and speech intelligibility in the press room.

Digital platforms were used for the distribution of radio and TV signals.

Cathedral of St. Andrea Apostolo - Amalfi - (sa)

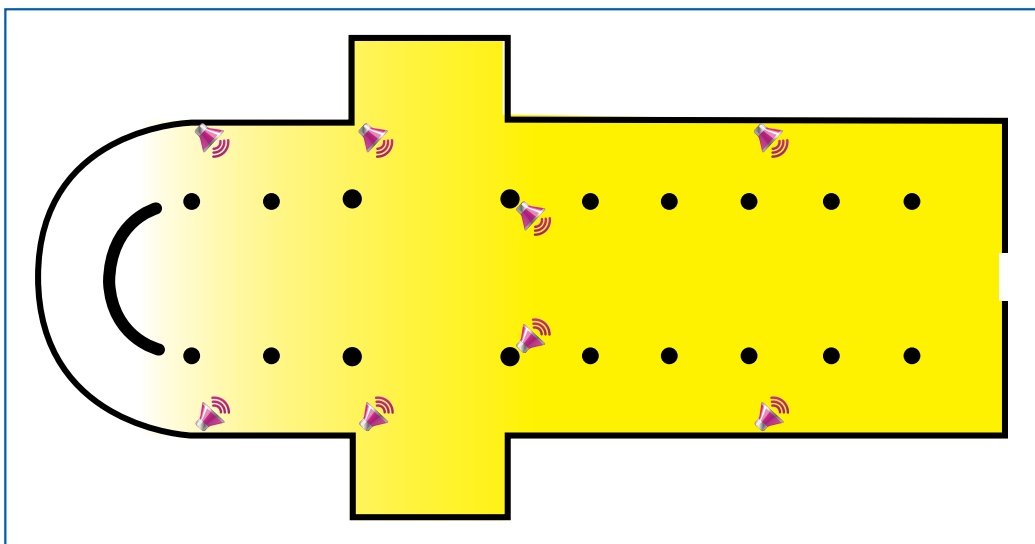

Digital audio system with high efficiency speakers.

mt. 80

Cathedral of Grasse - France



Cathedral of Brescia - New cathedral and old cathedral

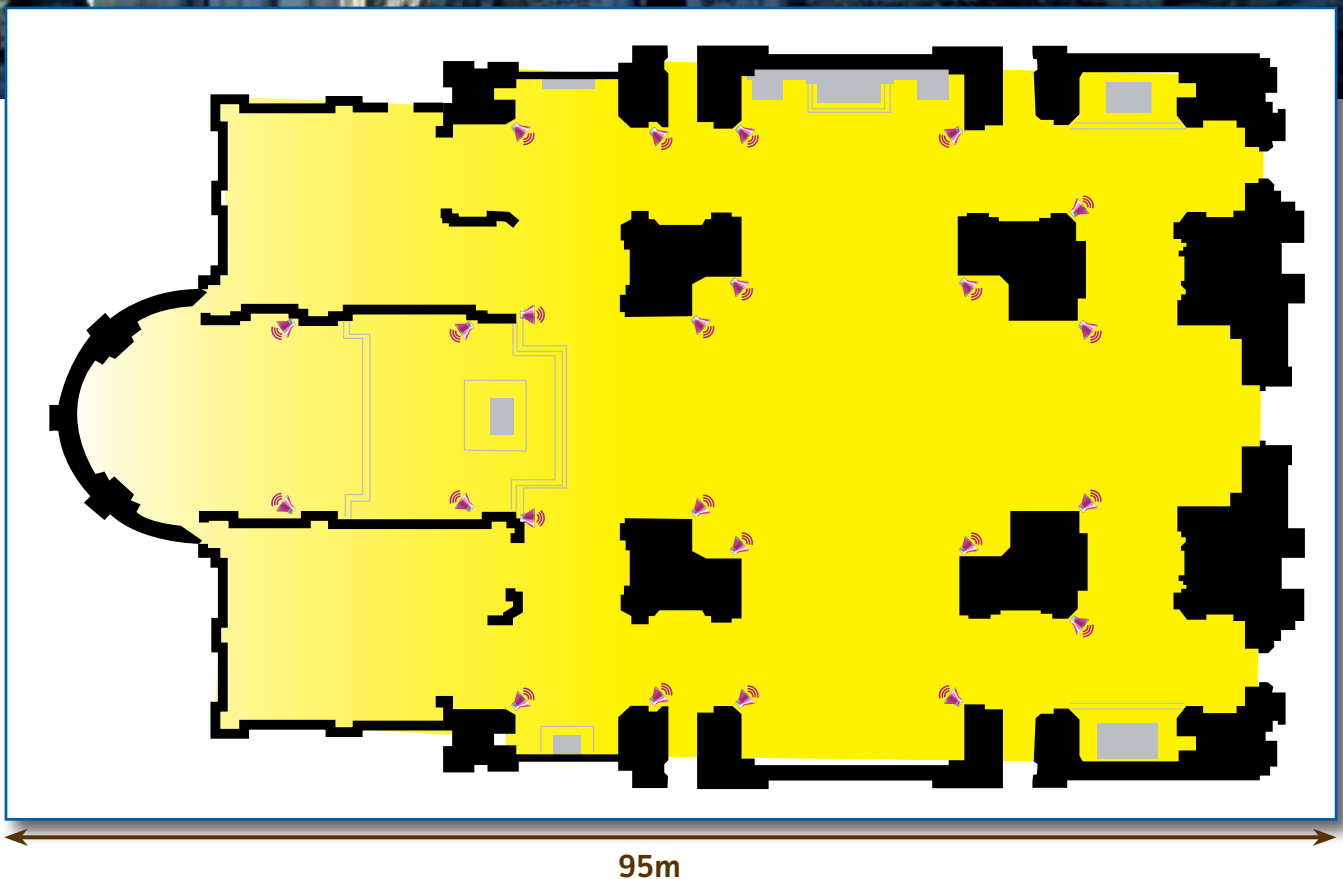

Ursian Basilica - Cathedral of Ravenna



FULGOR SERVICE

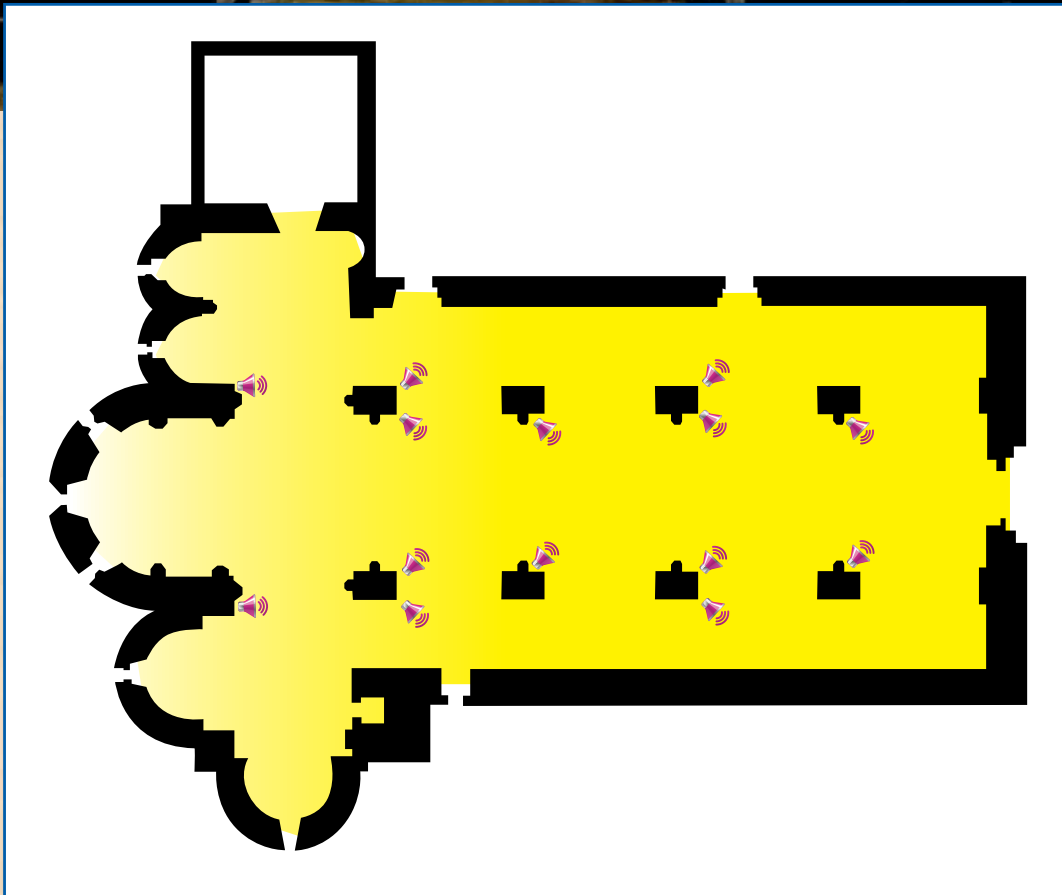

Digital Audio System with ACTIVO Speakers

Cathedral of St. Eusebio - Vercelli

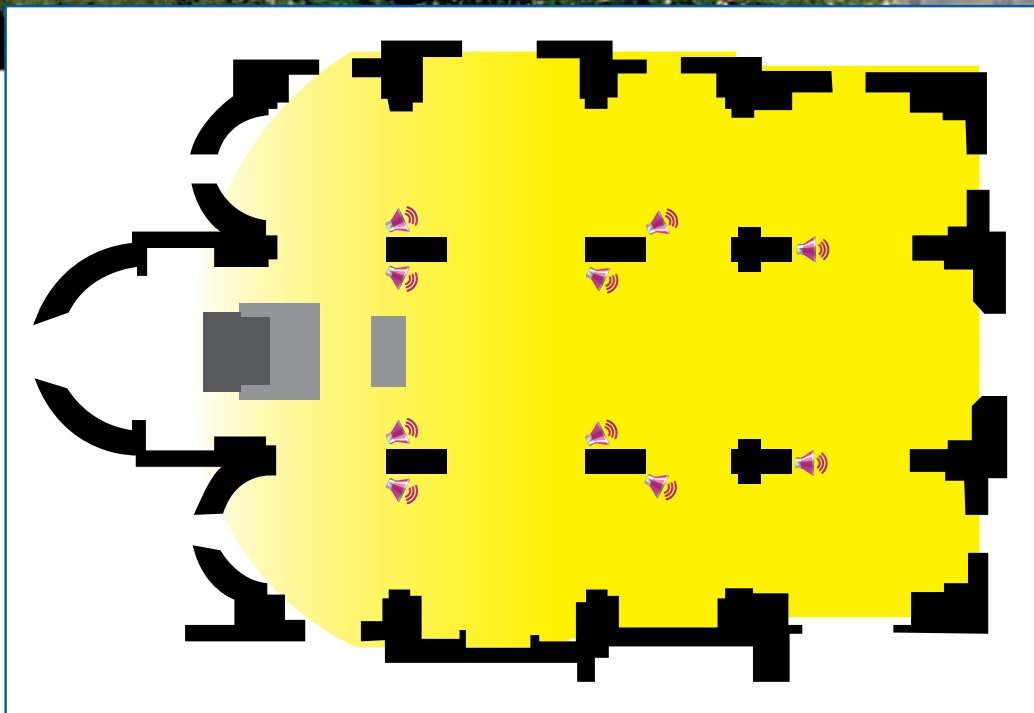

Cathedral of St. Francesco - Livorno



FULGOR SERVICE

'DIRECTIVITY', a Digital Audio system with controlled directivity guarantees the clarity and speech intelligibility in this Cathedral

Directivity

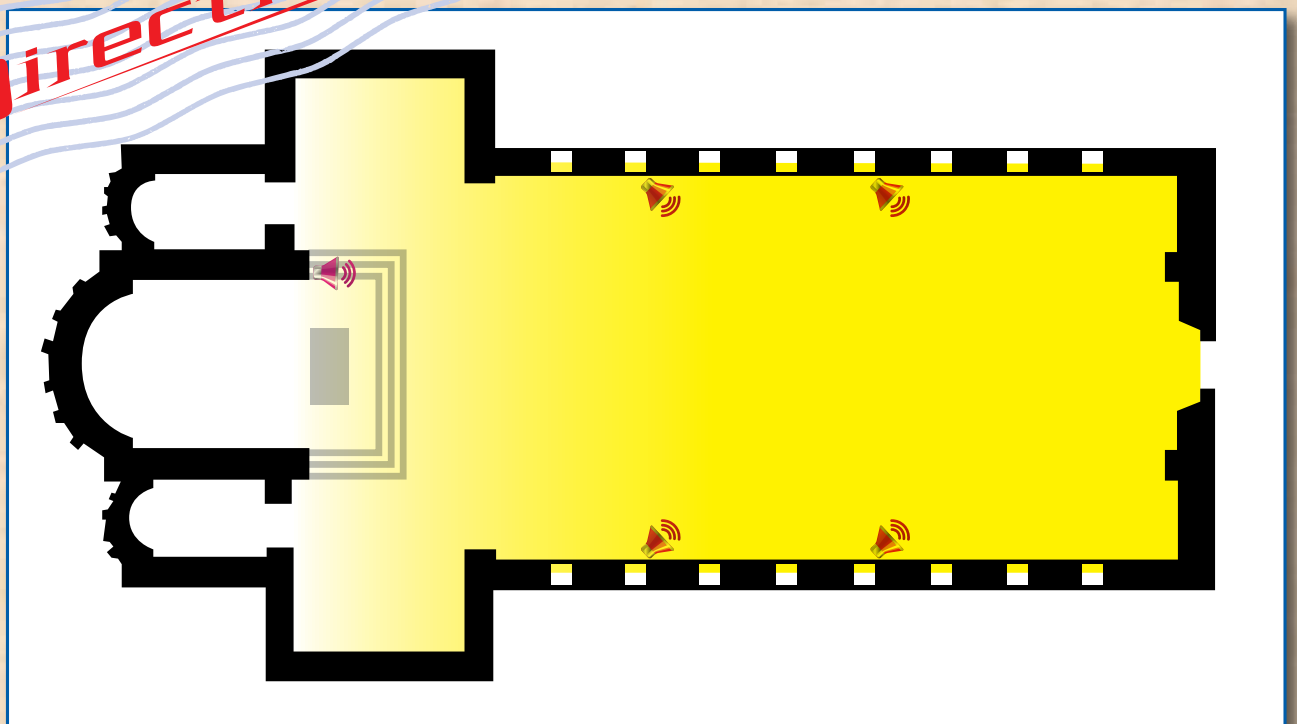

75m

St. Giorgio Duomo di Sassuolo - (Mo)



FULGOR SERVICE



'DIRECTIVITY' a Digital audio system with controlled directivity was required to reduce reverberation and ensure the clarity and speech intelligibility in this venue
An external system was also provided for processions using directional radio bridges at several locations.



Directivity

Cathedral Basilica St. Maria Assunta - Pesaro



FULGOR SERVICE

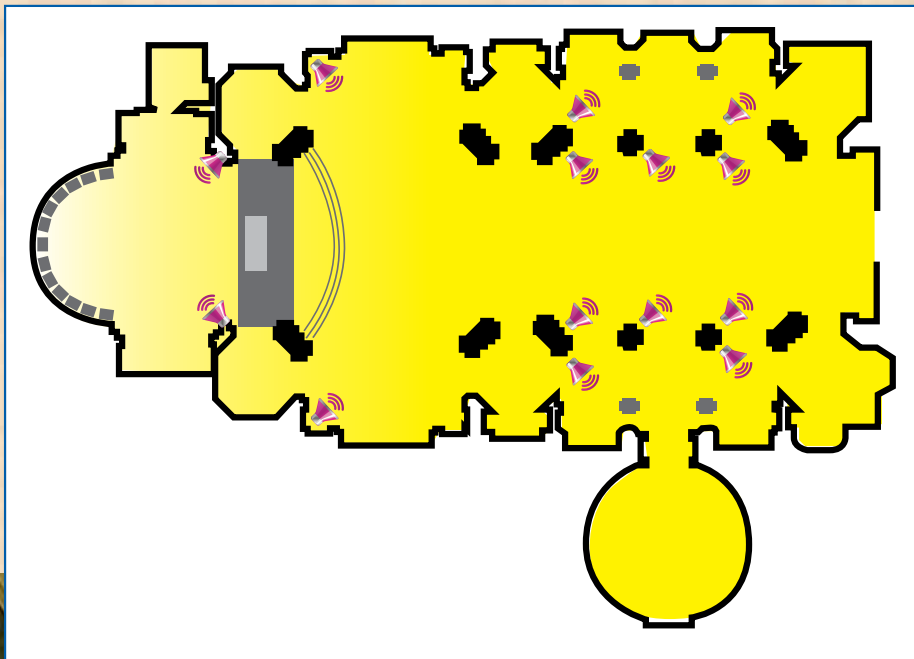

Digital Audio System
with ACTIVEO Speakers



Abbazia di St. Antimo - Montalcino - (si)



High Efficiency Digital Audio System

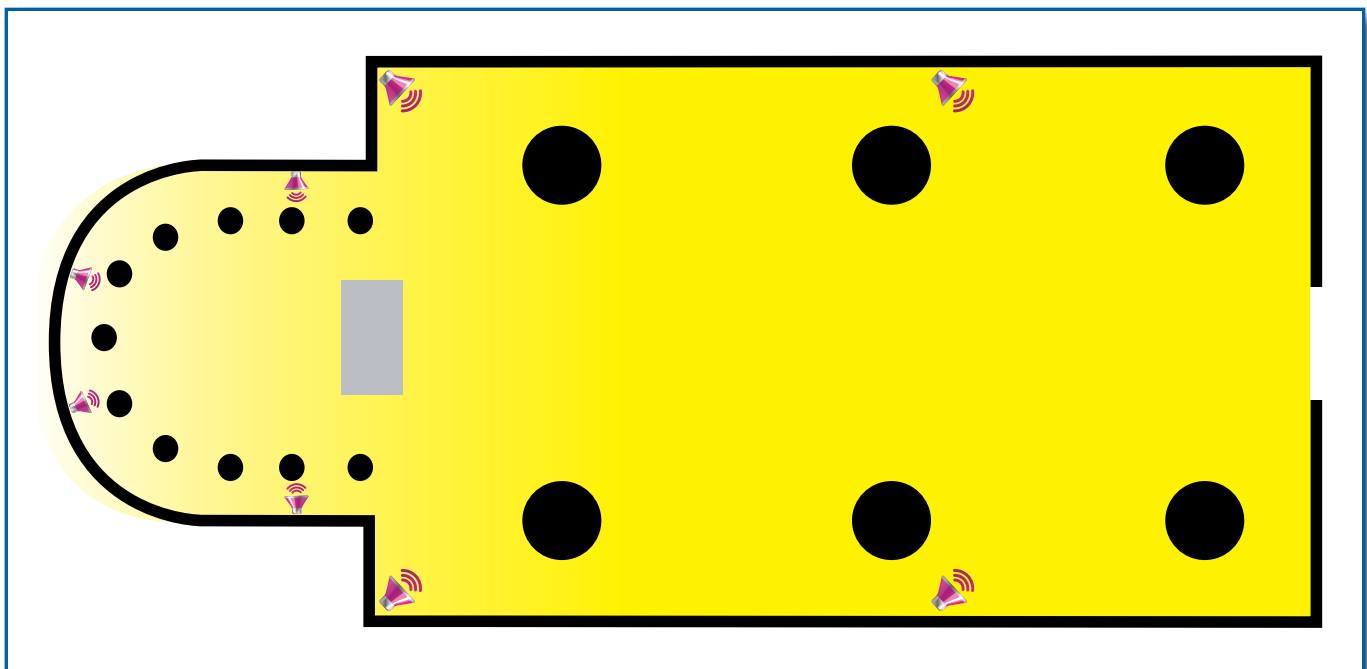

Cathedral of the Sacred Heart - Scutari - Albania

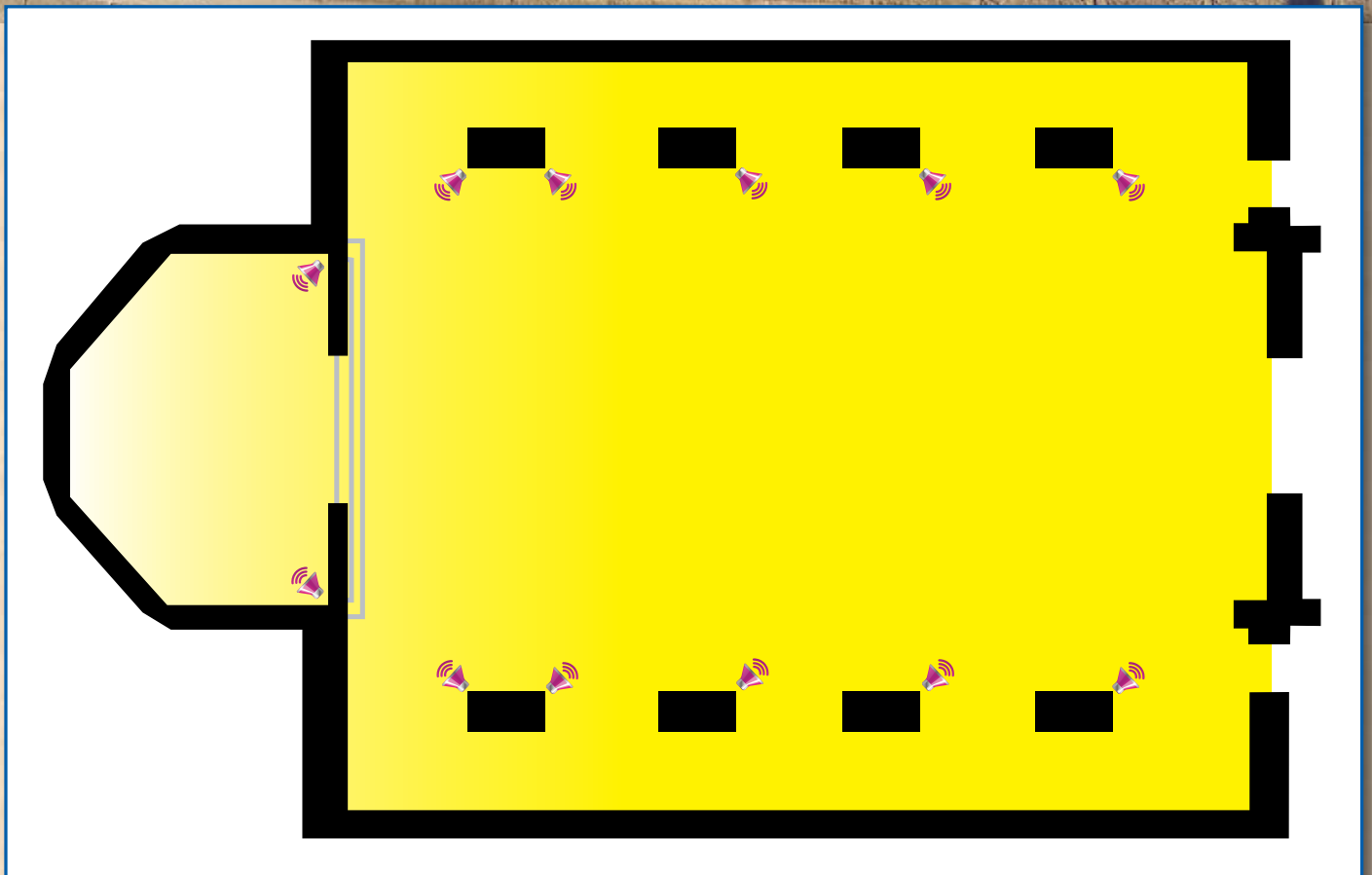

65m

Sanctuary of St. Maria del Fonte - Caravaggio - (Bg)

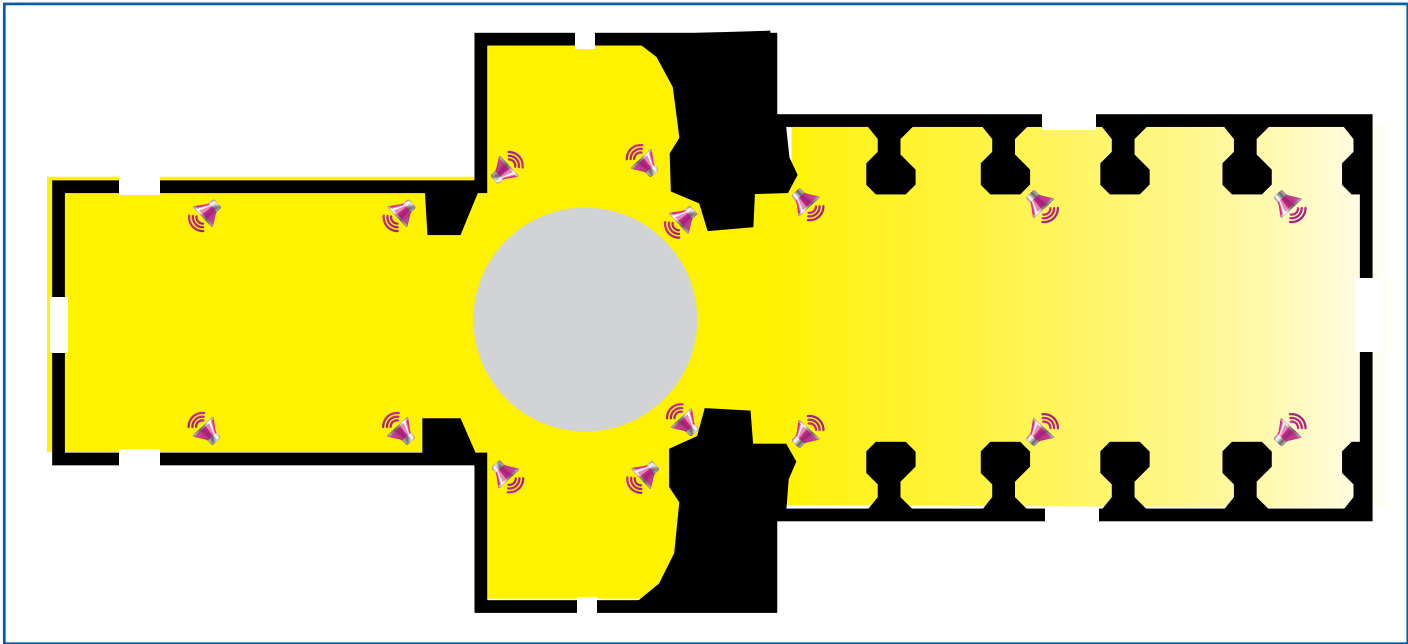

“Christ King” Cathedral of the Sepia - (SP)



FULGOR SERVICE

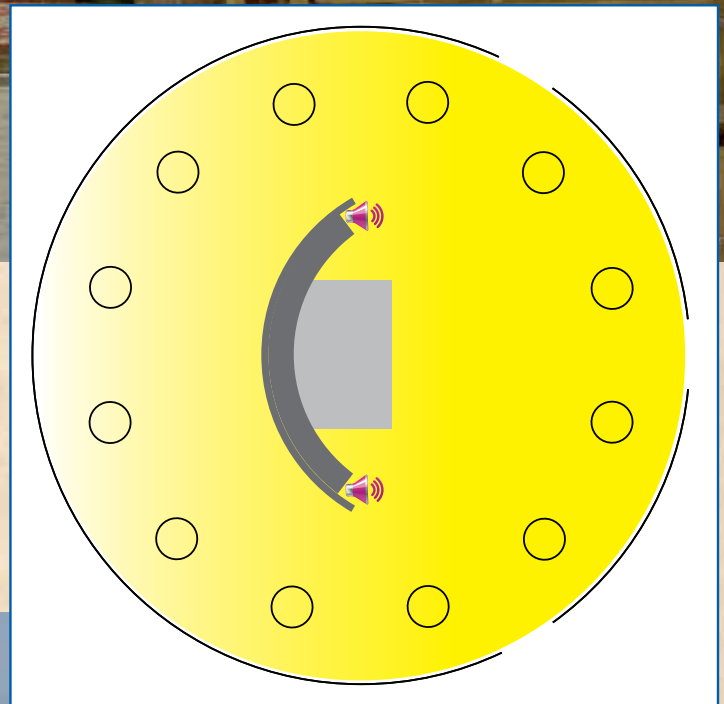

Directivity

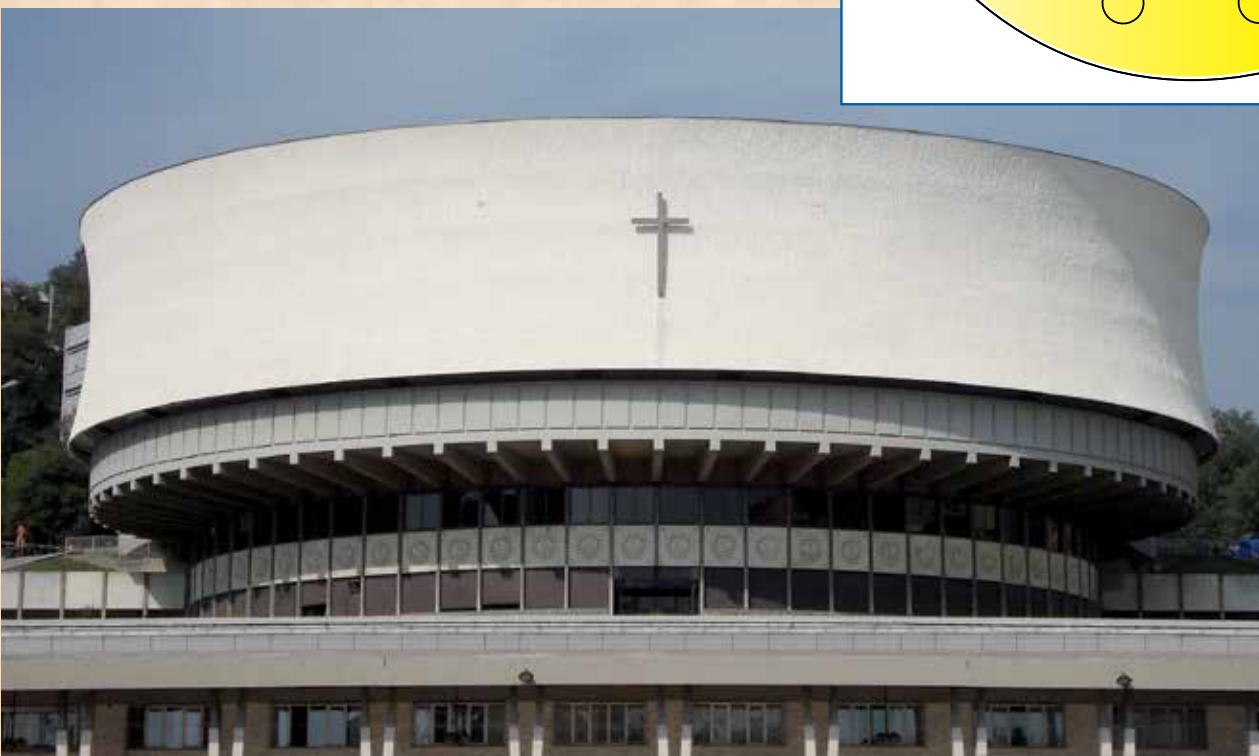

'DIRECTIVITY', a Digital Audio system with controlled directivity guarantees the clarity and speech intelligibility in this Cathedral

St. Maria Assumed in Heaven - Montecompatri - Rome



FULGOR SERVICE

Church of St. Andrea Della Valle - Rome



Digital Audio System with ACTIVO Speakers

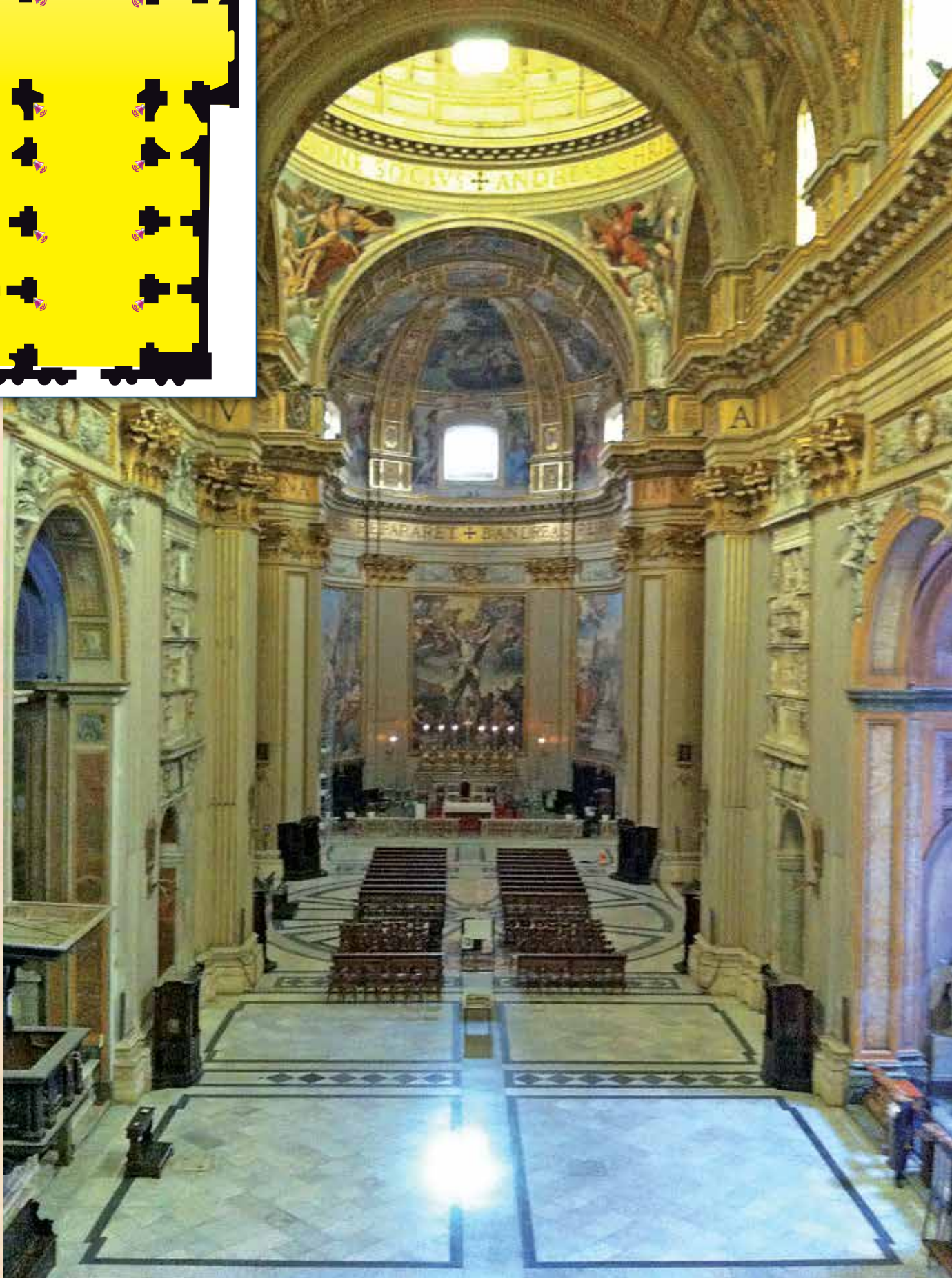
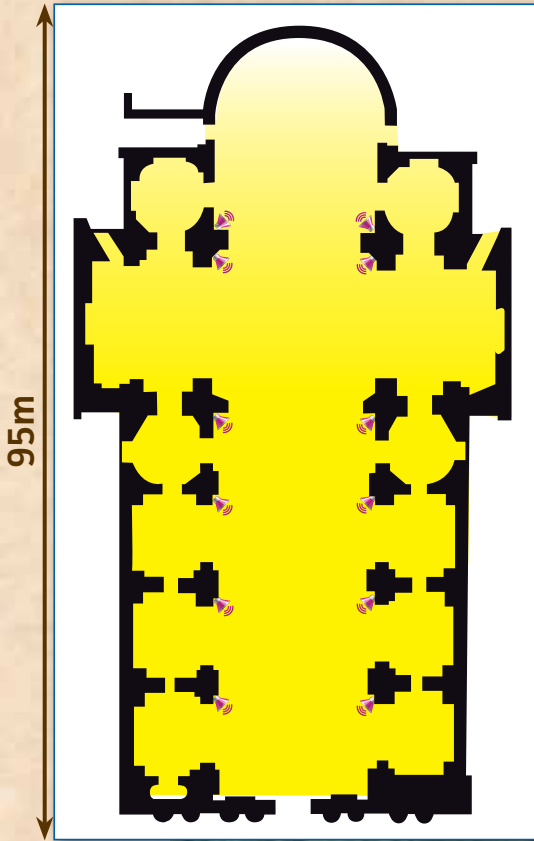

Cathedral of St Cerbone - Maritime Mass (gr)

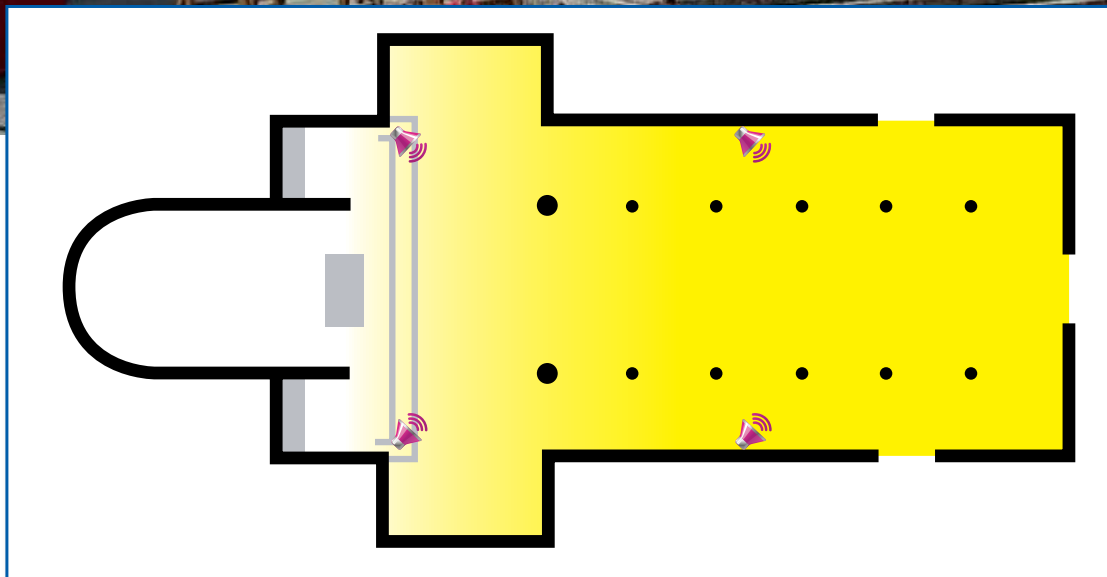

80m

Digital Audio System
with ACTIVO Speakers

Cathedral St. Maria Assunta - Fano - (Pu)

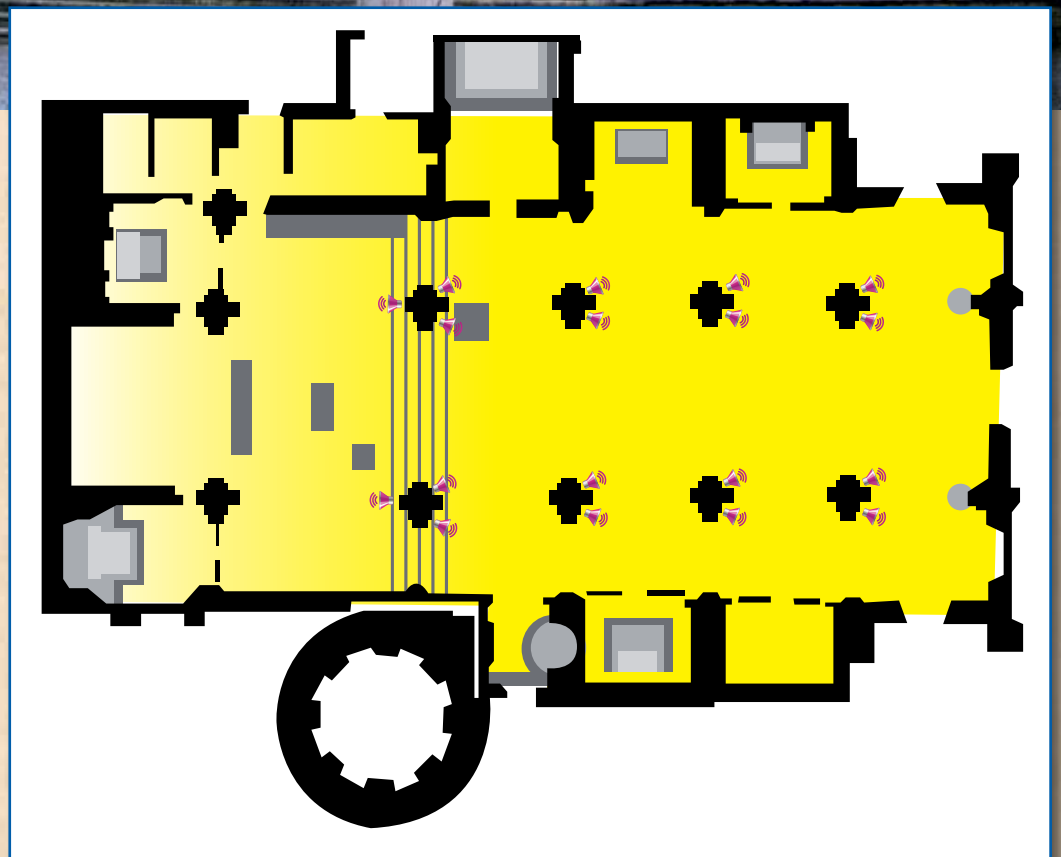

Cathedral of St. Zeno - Pistoia

Digital Audio System
with ACTIVO Speakers

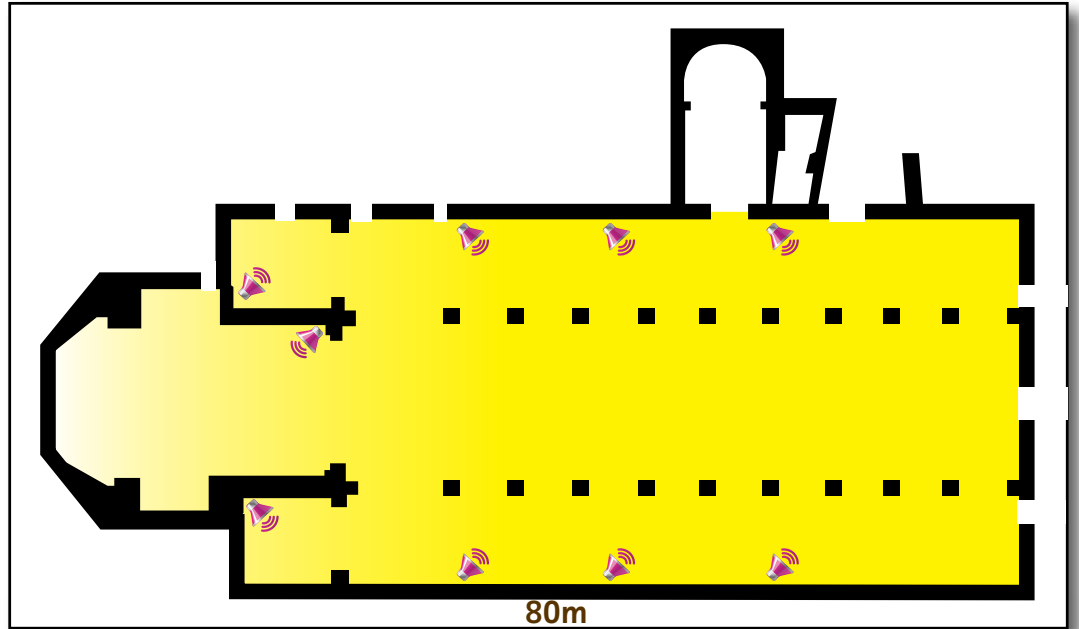

Sanctuary of Merciful Love - Collevalezza - Todi



Digital audio system in the upper, lower and outside Basilica.

Cellular system to carry out processions using radio microphones all along the Via Crucis for about 2 km.



FULGOR SERVICE

Cathedral of St. Venanzio - Fabriano - (An)

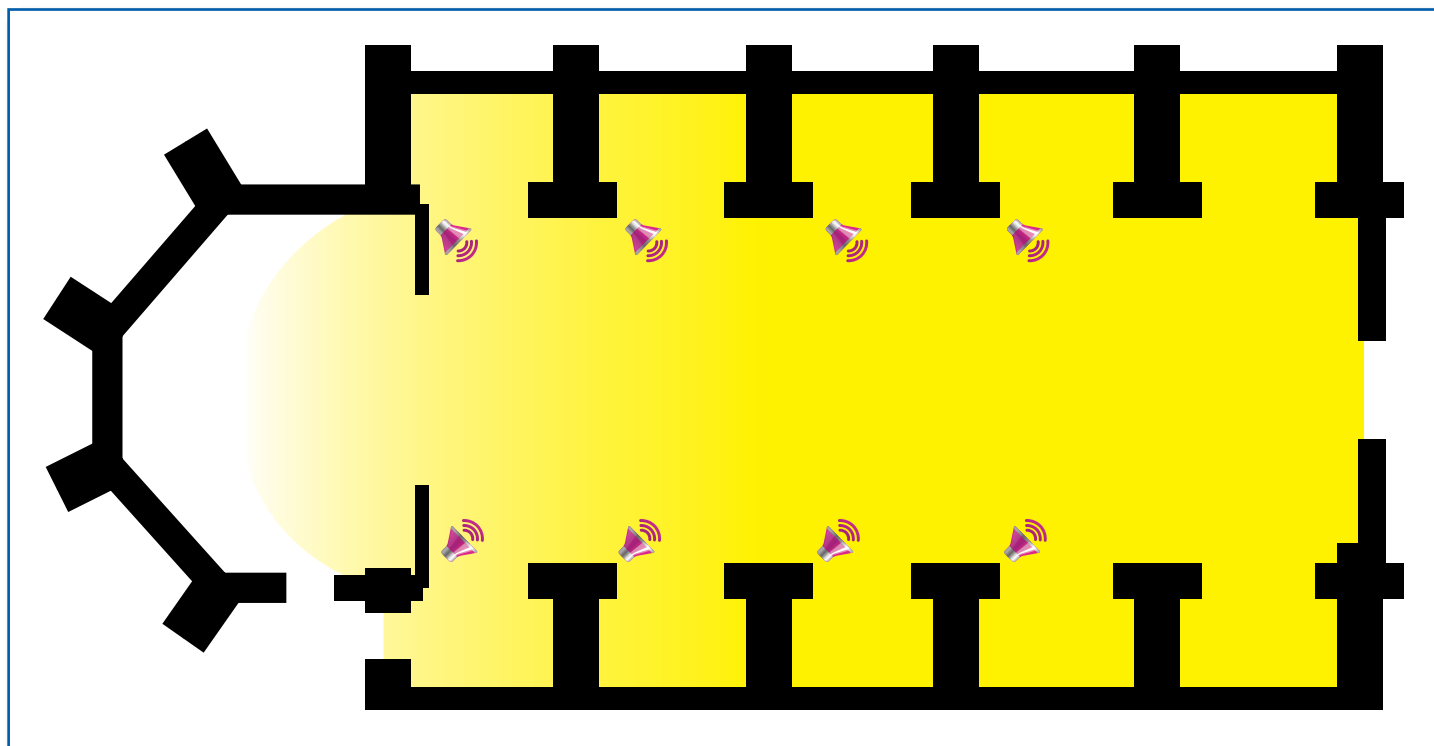

Digital audio system with
ACTIVO speakers

Pontificia Basilica St. Nicola - Bari



FULGOR SERVICE

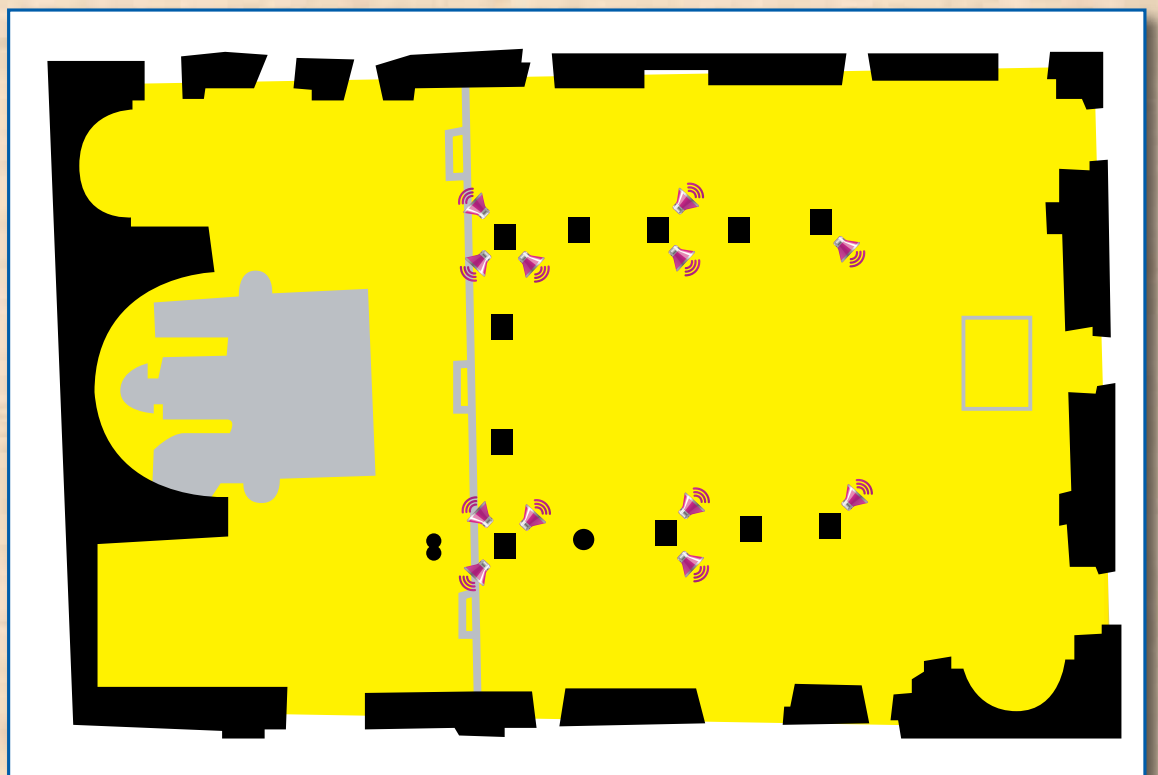

Cathedral of the Assumption- Ischia - (na)



FULGOR SERVICE

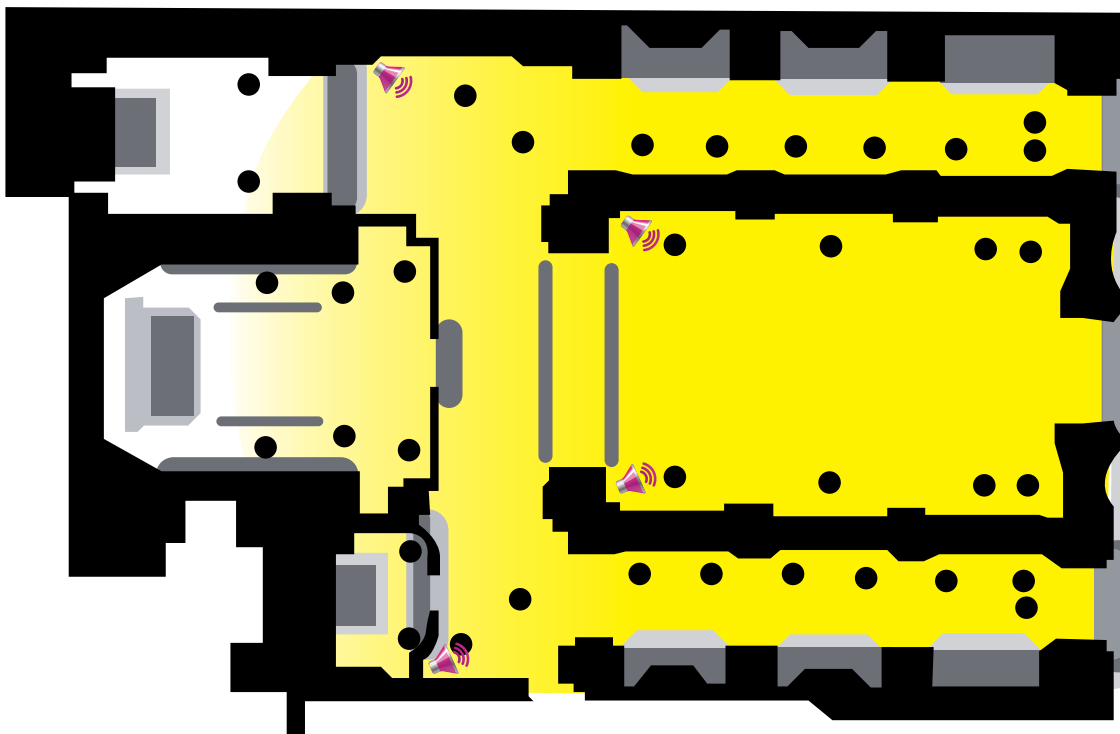



Parish St. Antonio Taumaturgo - Trieste

Digital Audio system with
ACTIVO speakers.



FULGOR SERVICE



Cathedral of St. Lorenzo - Grosseto

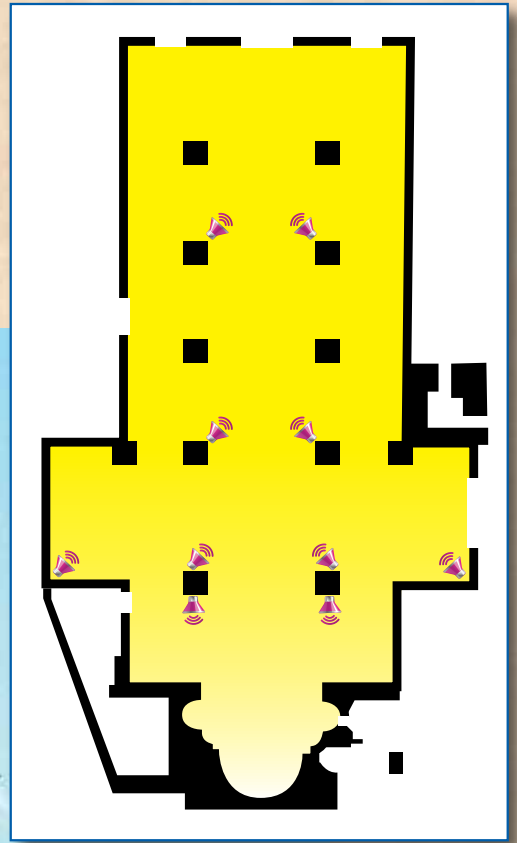

Cathedral of St. Stefano - Prato

Digital audio system with
ACTIVO speakers

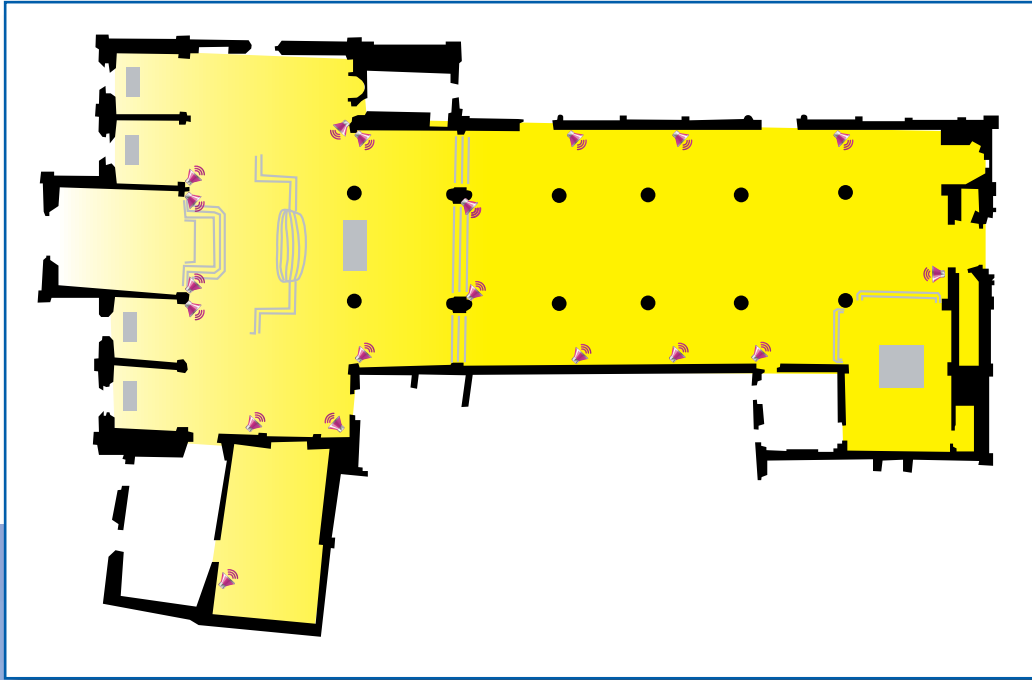

80m



FULGOR SERVICE



Sanctuary of "Nuestra Señora de Luján" - Argentina

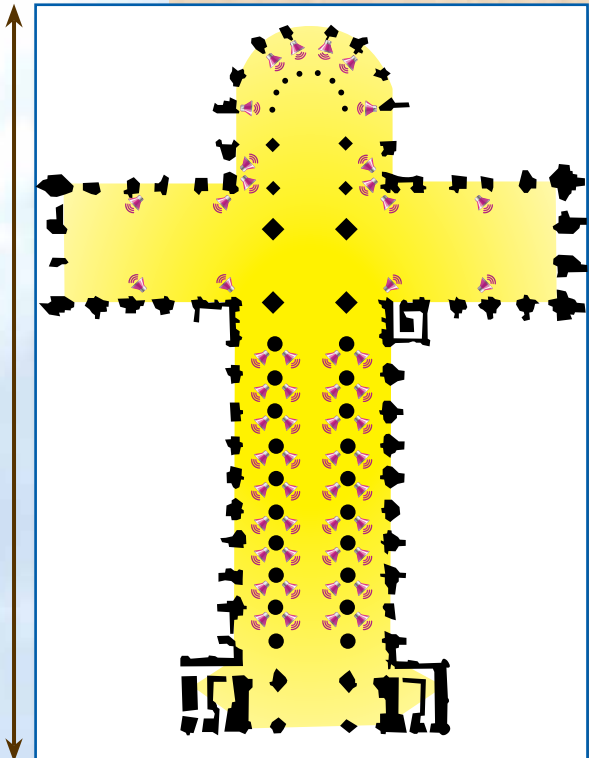

Battistero di Parma

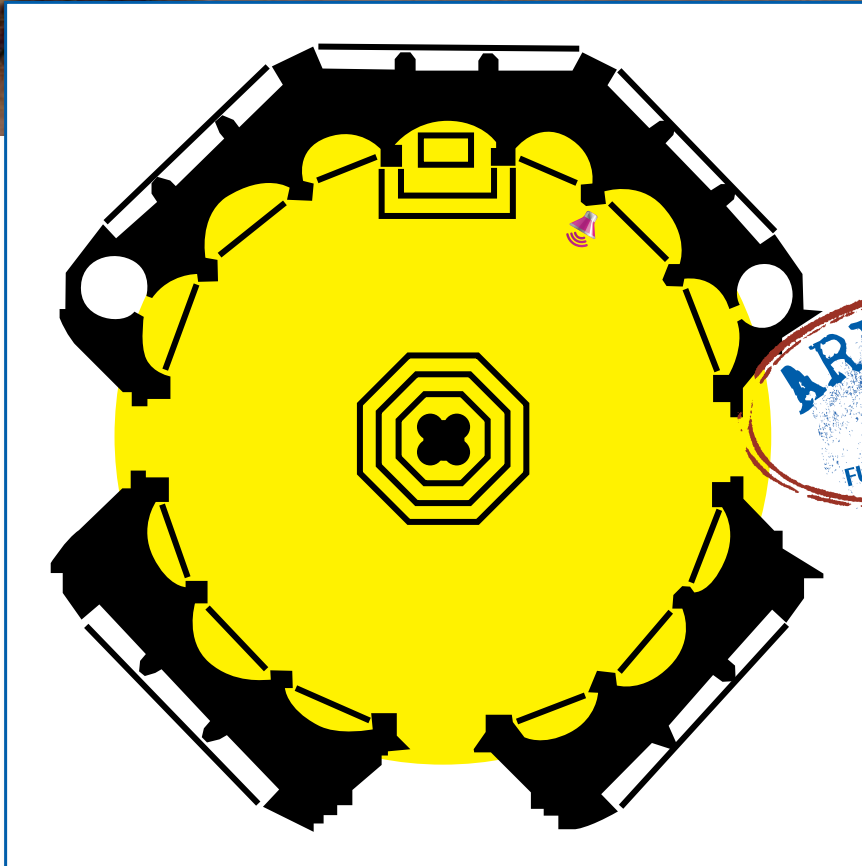

The audio system consists of just one "Arianna" speaker a wireless battery powered line array speaker which can be positioned anywhere to suit the occasion.

Basilica of St. Domenico - Siena

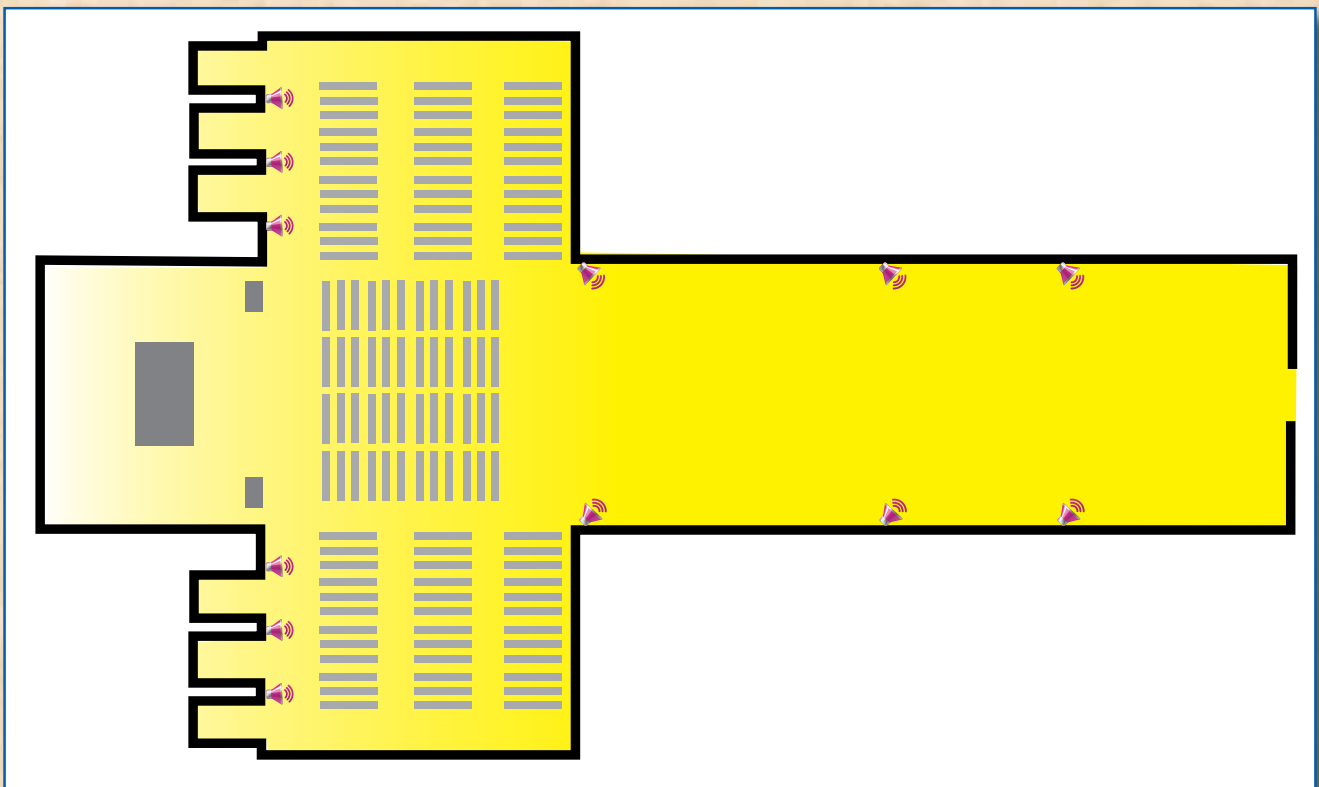

Mass Cathedral - Cathedral of St. Peter and St. Francis



FULGOR SERVICE

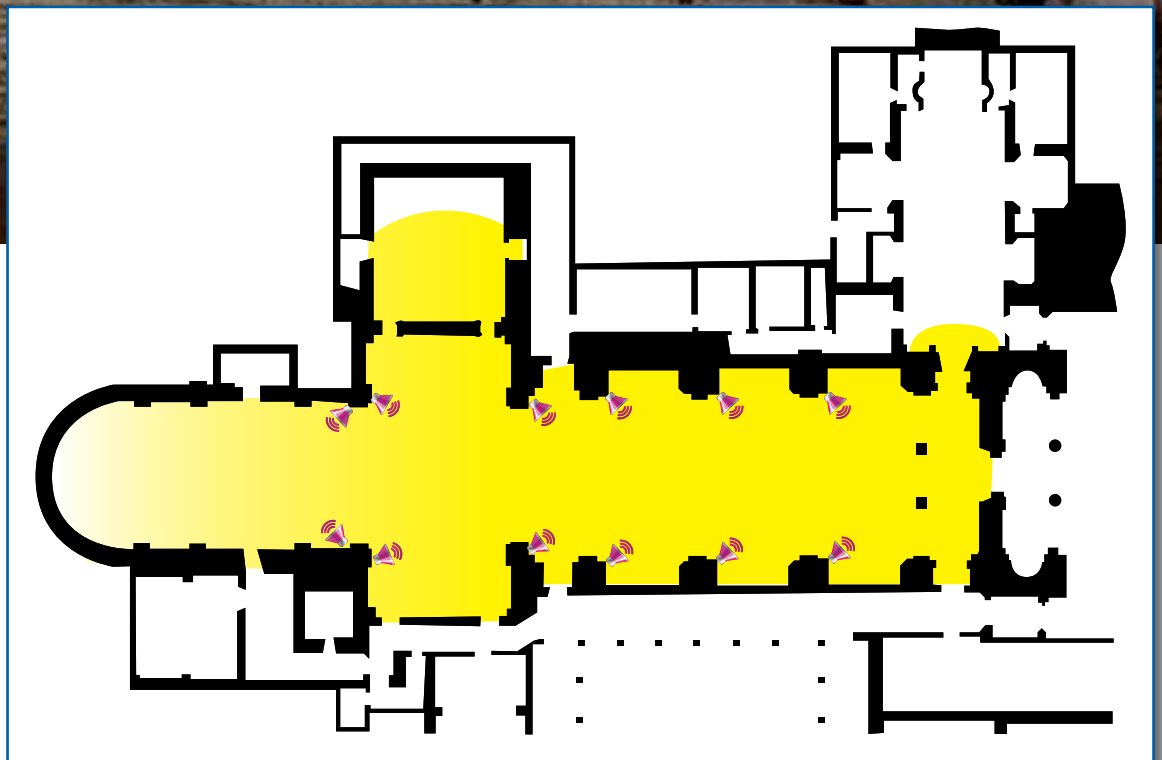

80m

Quadrivium Hall - Archdiocese of Genoa



FULGOR SERVICE

Parroquia de la Concepcion de la Orotava - Tenerife



Cathedral of St. Paolo - Alatri (fr)



Digital audio system with
high efficiency speakers

Cathedral of St. Donnino - Duomo di Fidenza - (Pr)



High efficiency speaker system



Cathedral of St. Clemente - Velletri - Rome



'DIRECTIVITY', a Digital Audio system with controlled directivity guarantees the clarity and speech intelligibility in this Cathedral



Directivity

Basílica of St. Maria del Pi - Barcellona - Spain



FULGOR SERVICE



Basilica St. Maria delle Vigne - Genoa

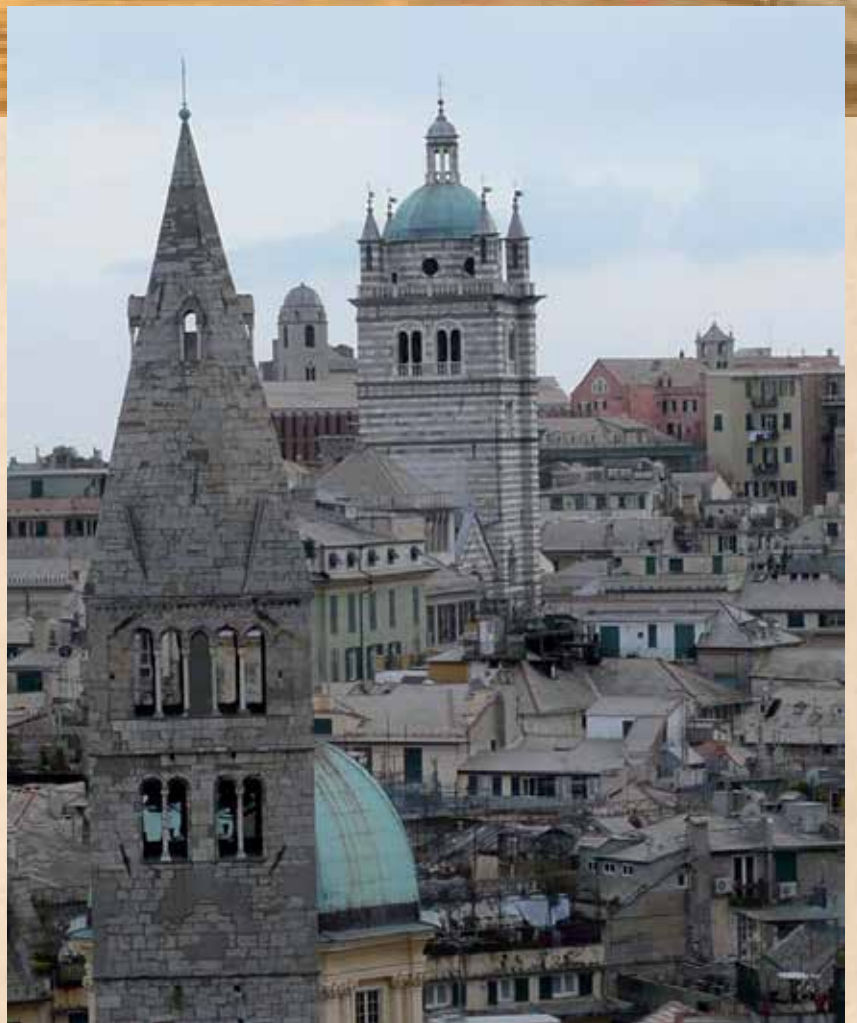

FULGOR SERVICE

Cathedral of St. María de Cordoba - Spain

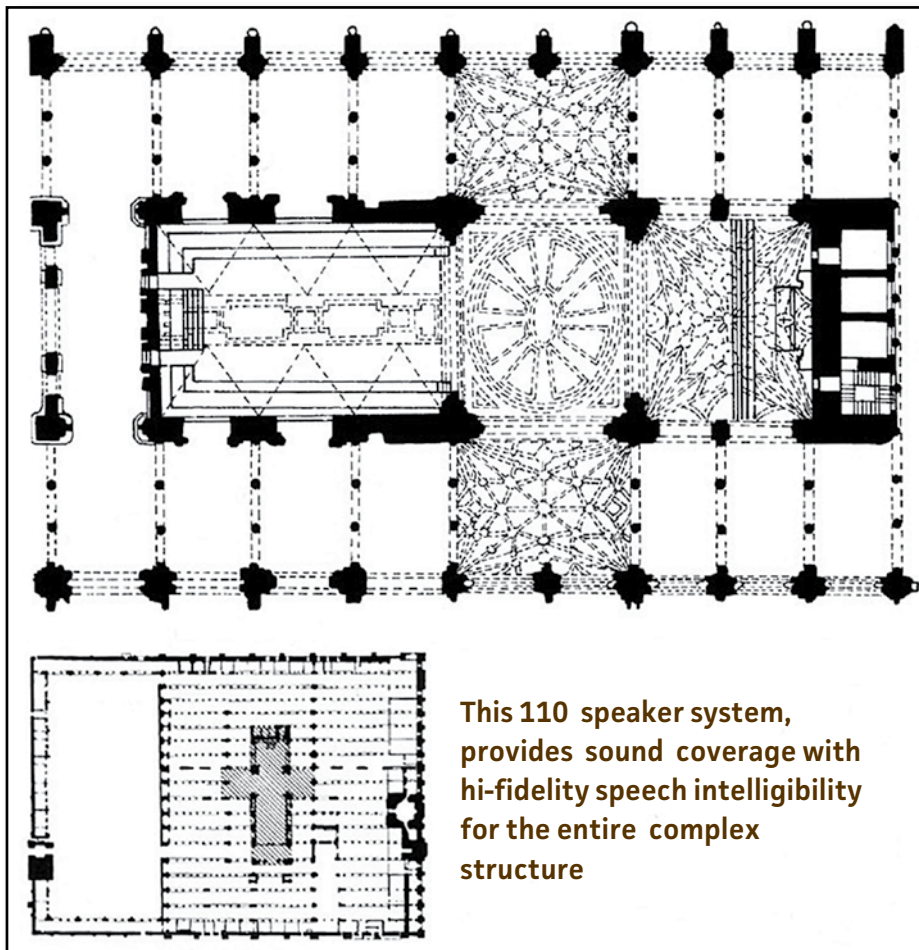

This 110 speaker system, provides sound coverage with hi-fidelity speech intelligibility for the entire complex structure

Sanctuary Virgen de la Candelaria - Tenerife



Sanctuary of the St. Crucifix - Meda (Mb)



Directivity

Digital audio system
with controlled
directivity.

FULGOR SERVICE

Pontifical Sardinian Regional Seminary of the Sacred Heart of Jesus - Cagliari

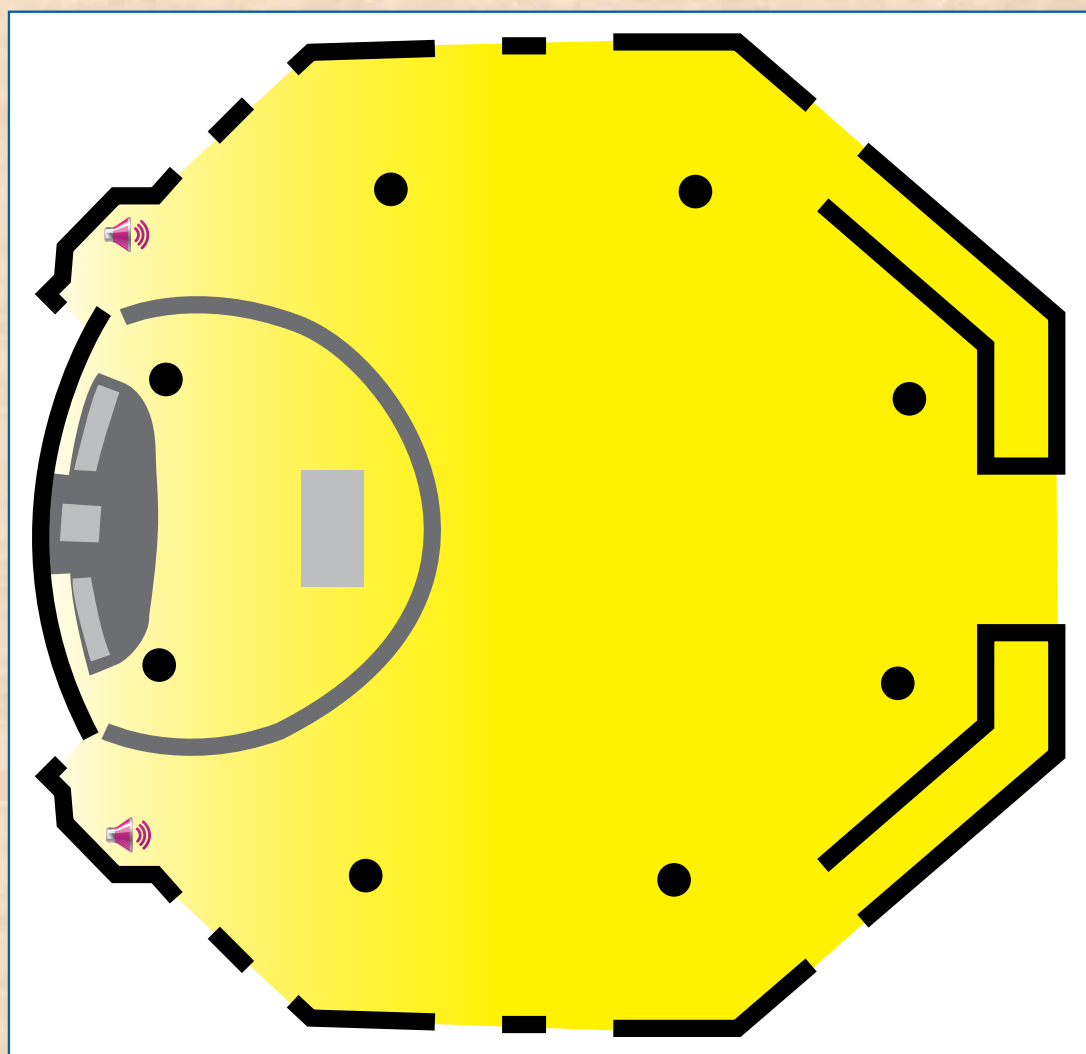

Church of the Sacred Family - Prato



Digital audio speaker
system with controlled
directivity

Metropolitan Cathedral of Buenos aires - argentina

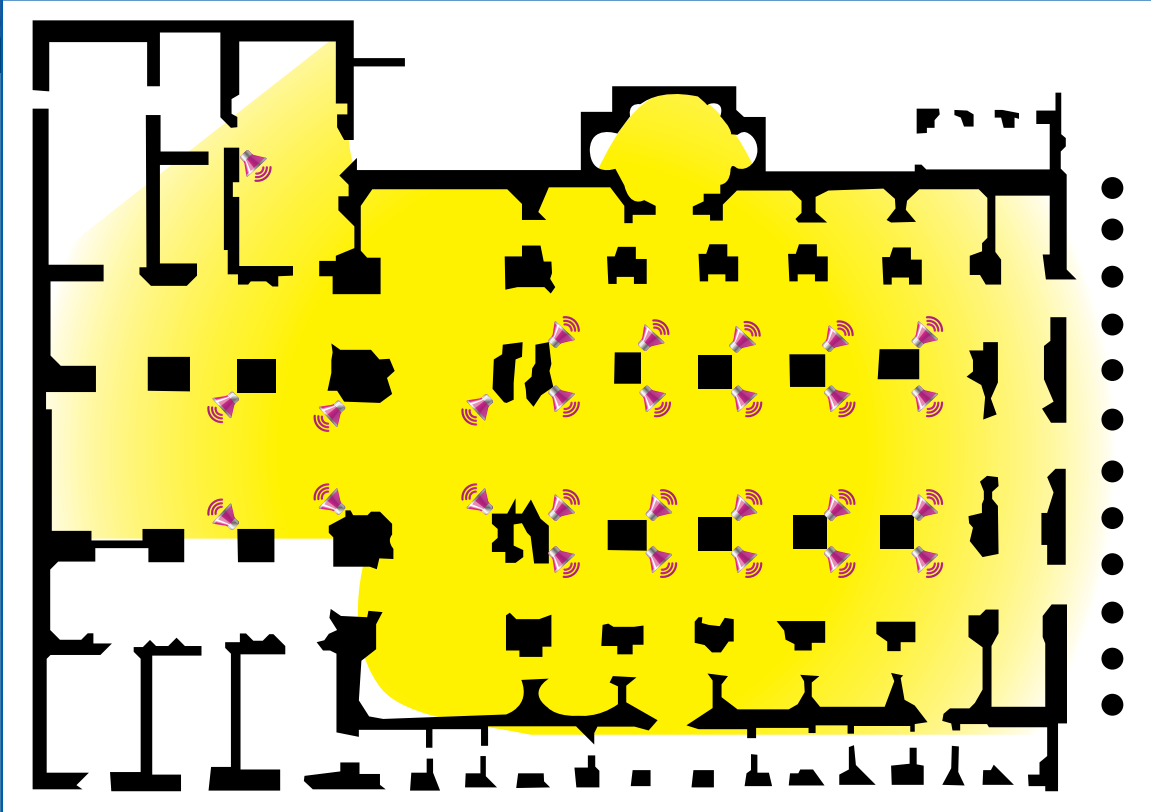

80m

Cathedral of Maria Santissima Taken in Heaven - Capua - (Ce)

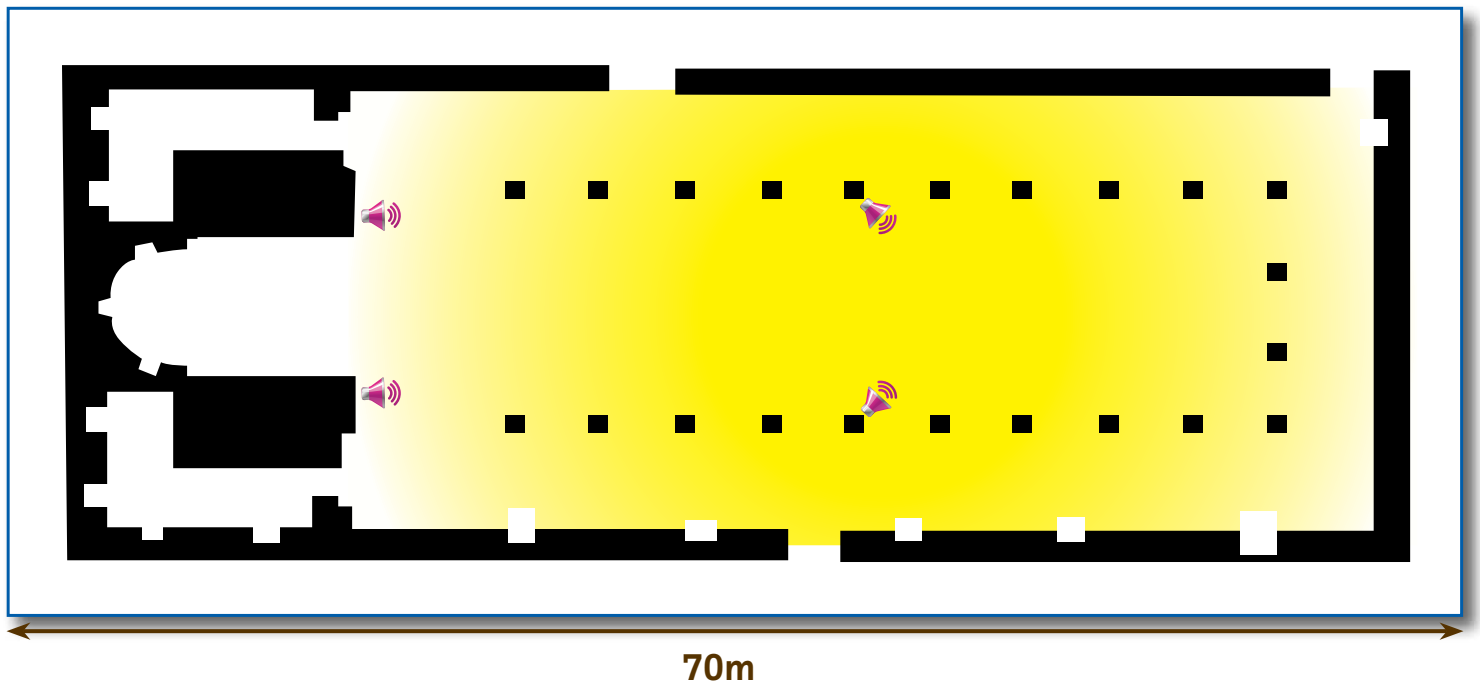

Co-Cathedral of St Giovenale Duomo Of Narni - Terni



FULGOR SERVICE



Arcipretura Basilica collegiata of St John the Baptist Monza - (Mi)



Cathedral of Nuestra Señora la Paz - Bolivia

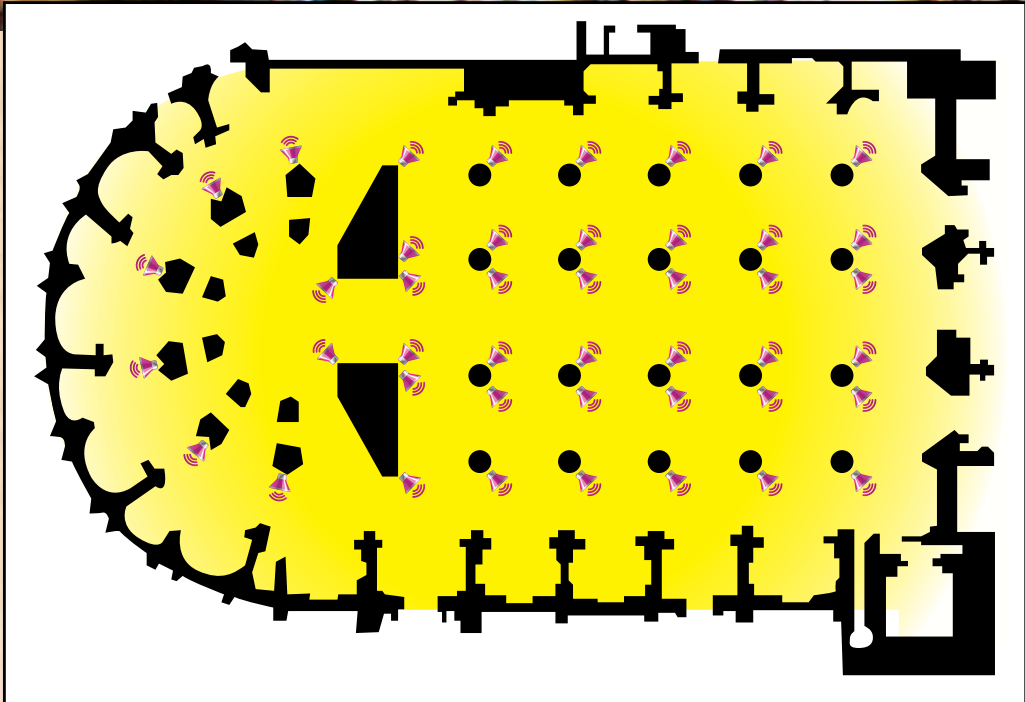

Santa. Maria del Mar - Barcellona - Spain



Distributed digital Audio System

Basilica of Santa Maria in Montesanto - Rome



FULGOR SERVICE



Cathedral of Santa Maria Della Neve - Nuoro

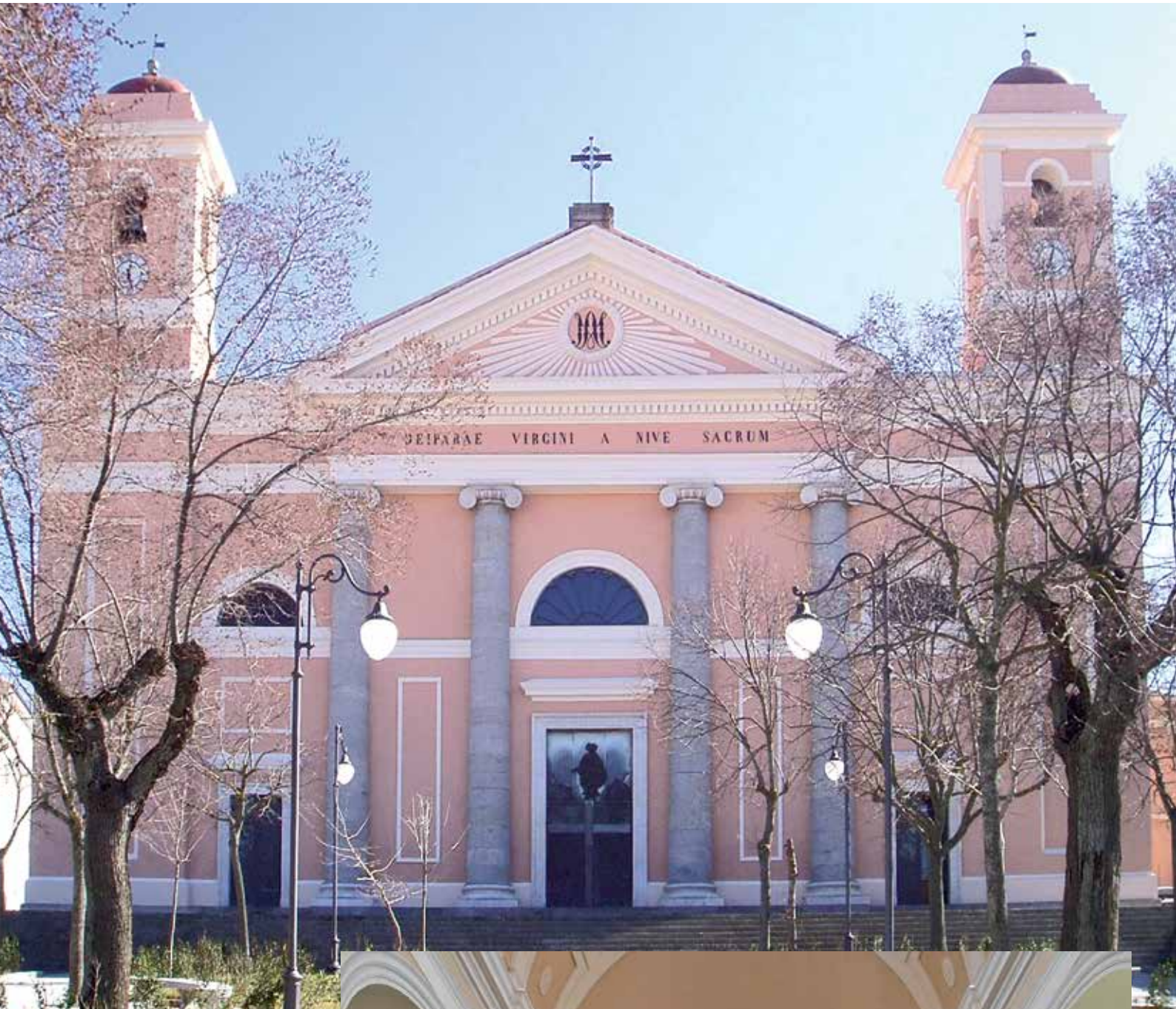

FULGOR SERVICE

Basilica of Mercy- Barcellona - Spain



FULGOR SERVICE



Digital audio system
with high efficiency
speakers

Cathedral of Acerenza - Potenza



FULGOR SERVICE



Basilica of Sant'Apollinare nuovo - Ravenna

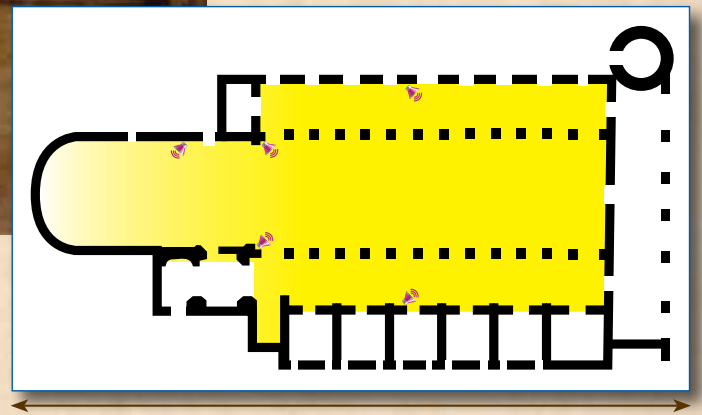

Digital Audio System

70m

Basilica Of St Apollinare in Classe - Ravenna

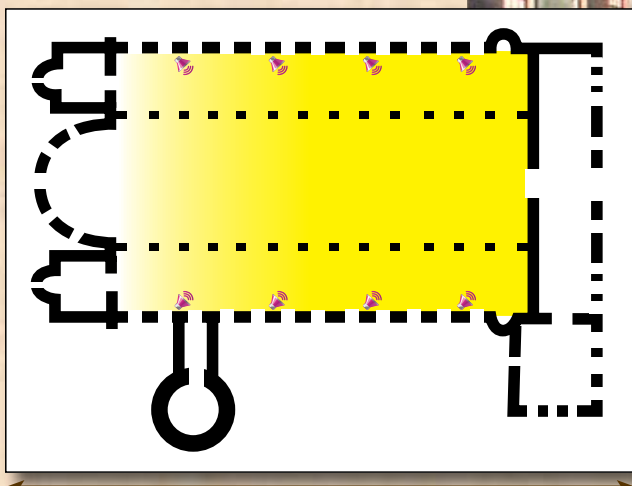

70m

Parish of St Giovanni Apostolo - Marotta (Pu)



Parish of Gesu' Divino Operaio - Trieste



This church is octagonal with an altar in the center. The acoustics are very challenging.
2 RAE speakers with an auto-mixer were used. The speakers were mounted on painted steel posts and placed directly in the nave.

Church of St. Filippo Neri - Genova



Parish Church of Saints Pietro and Andrea Fenile of Fano (Pu)



Saints Gervasio and Protasio in Duomo - City of Pieve - (Pg)

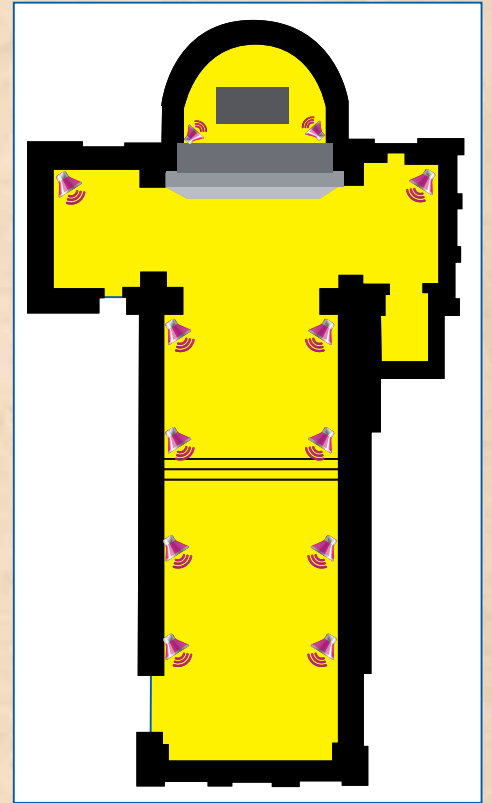

Church of Sts. Andrea and Bartolomeo - Orvieto - (Tr)



FULGOR SERVICE

National Temple of Madonna del Conforto - Cargnacco - (ud)

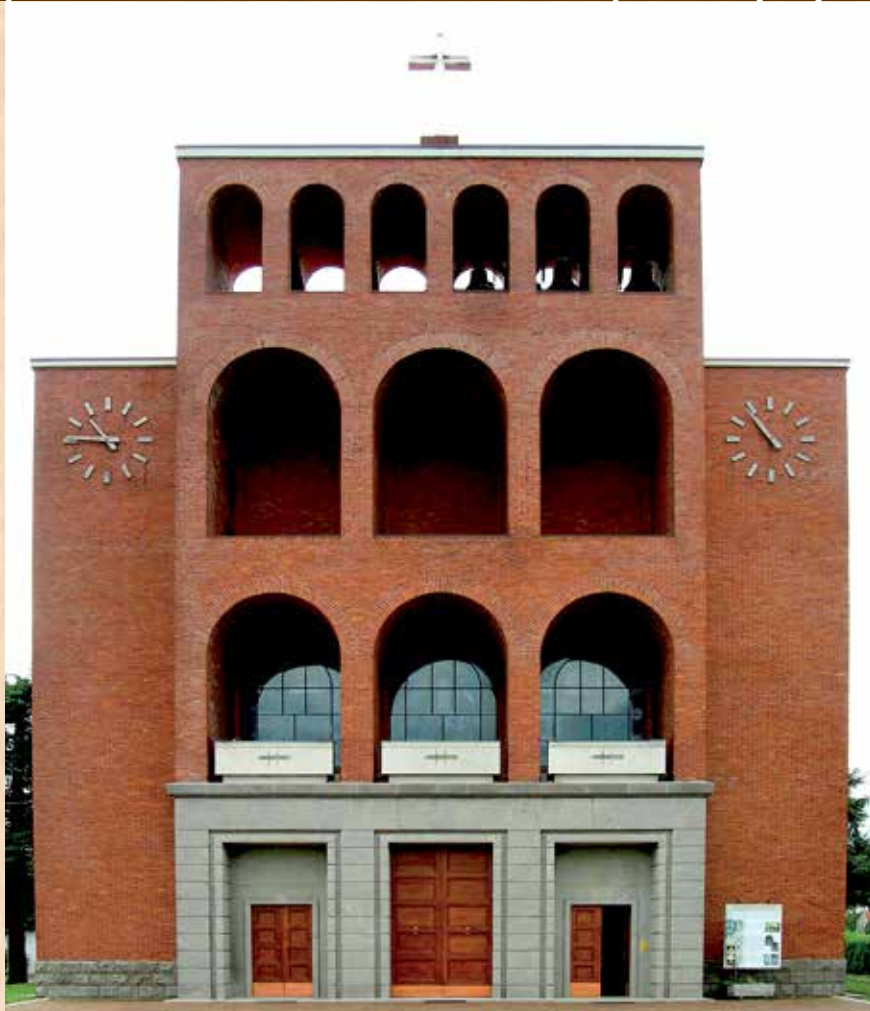

Basilica of St. Valentino - Terni

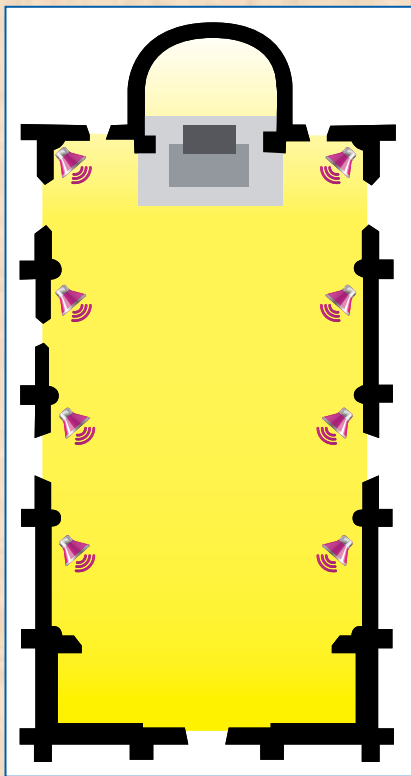

Church of Devine Mercy - St. Bartolomeo al Mare - (Im)

Digital audio speaker system with controlled directivity

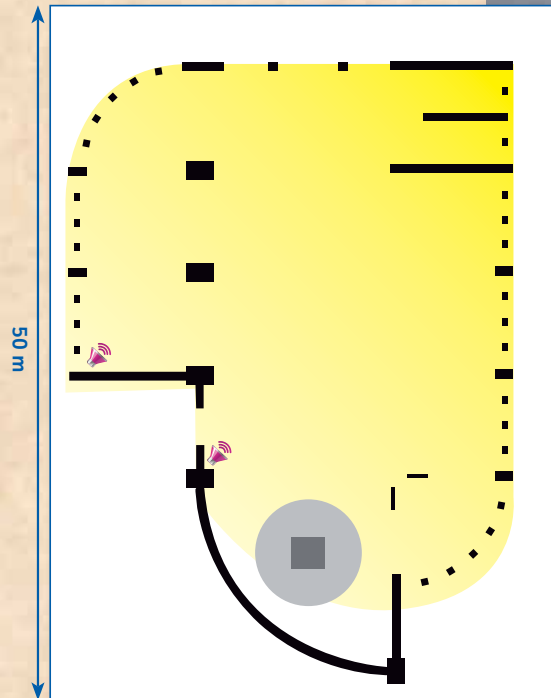

Directivity

Family of the immaculate Heart of Maria Church of St. Frediano - Montignoso - (Fi)

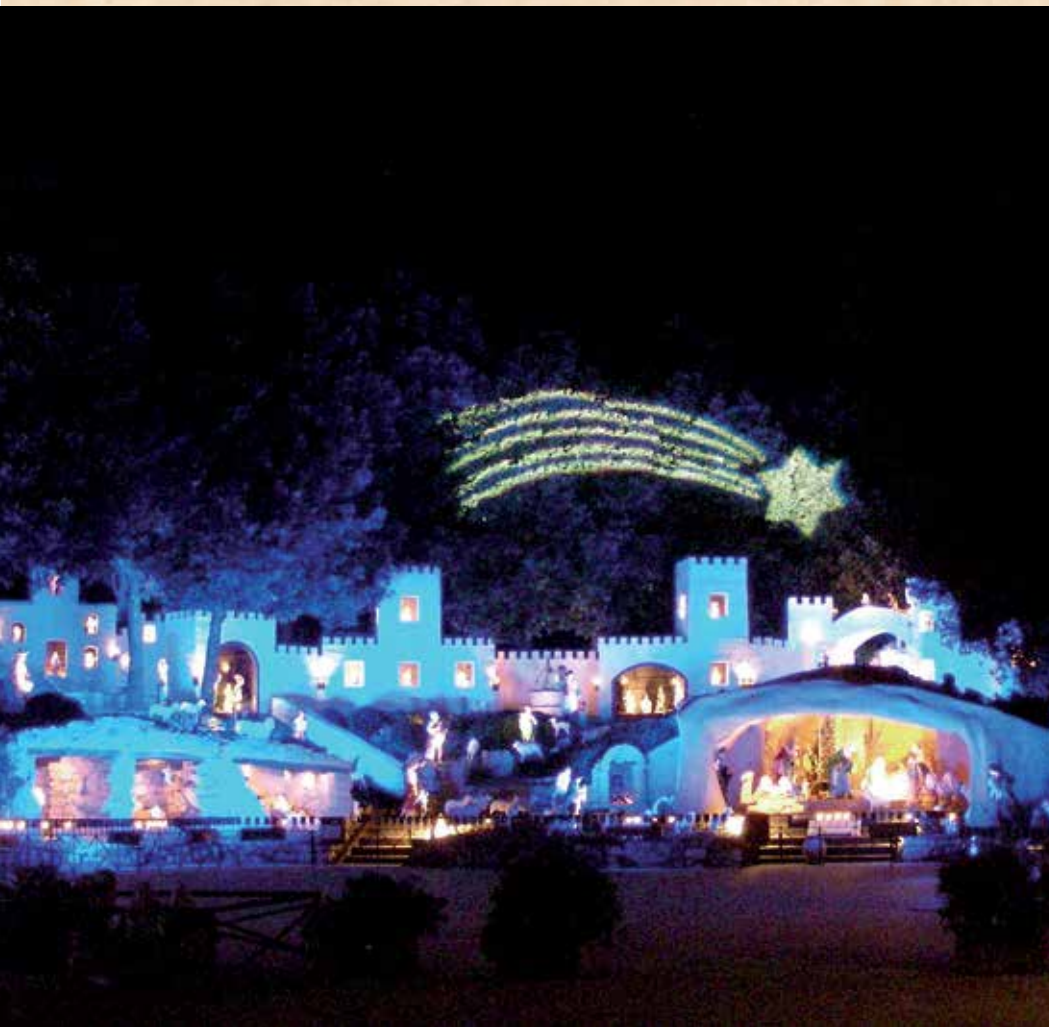

The digital audio management system is centralised

It provides audio signals to speakers in two churches the Via Crucis, the Nativity, the Via del Rosario and the outdoor path where events and periodic processions take place.

The equipment, both speakers and digital audio management system is designed and manufactured by Fulgor Services



FULGOR SERVICE

Seminario of Righi - Genova

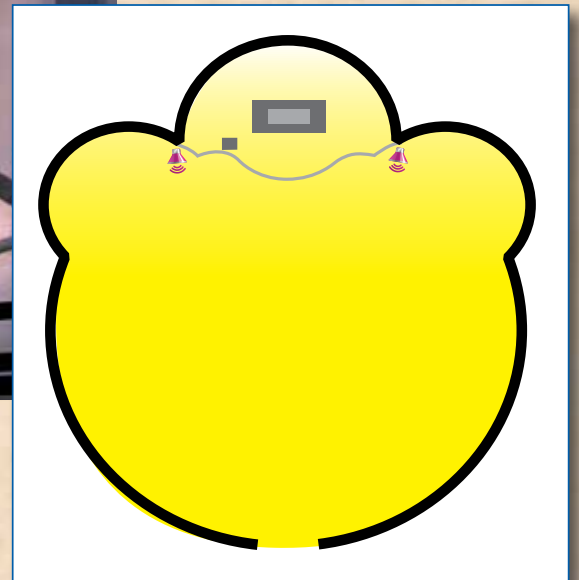

Parish of the Sacred Heart of Monza - (Mi)

'DIRECTIVITY', a Digital Audio system with controlled directivity guarantees the clarity and speech intelligibility in the Sacred Heart of Monza



Directivity

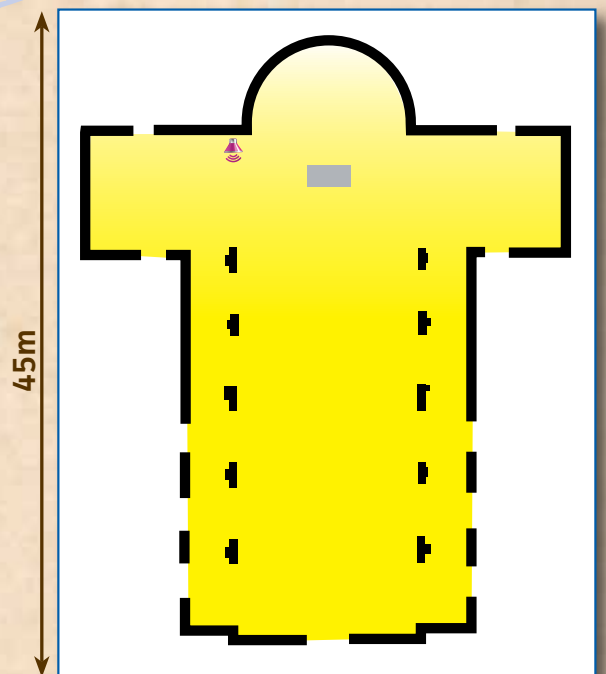

Parish of Santa Maria - Cernusco - (Mi)

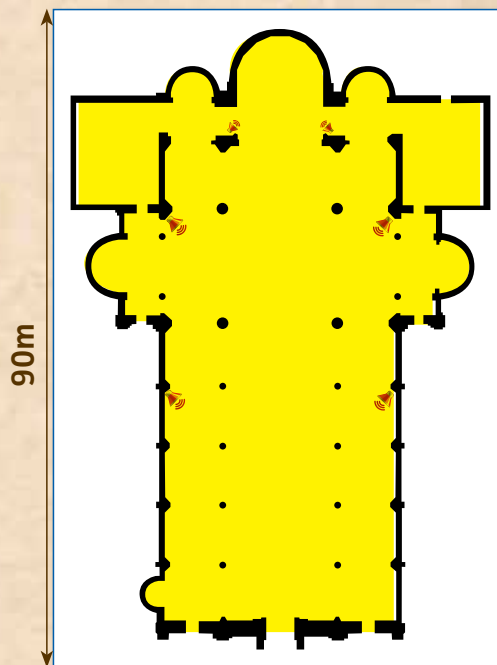

Directivity

Abbey of St. Salvatore - Siena

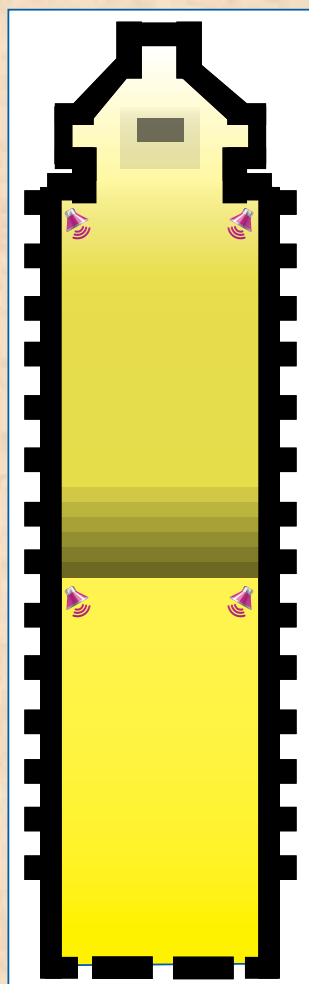

Sanctuary of Our Lady Lourdes - Verona



The Shrine of Our Lady of Lourdes, Padri Stigmatini, is located in the city of Verona which is dominated by the height of its hill.

Fulgor Service voice broadcasting system with Active loudspeakers.

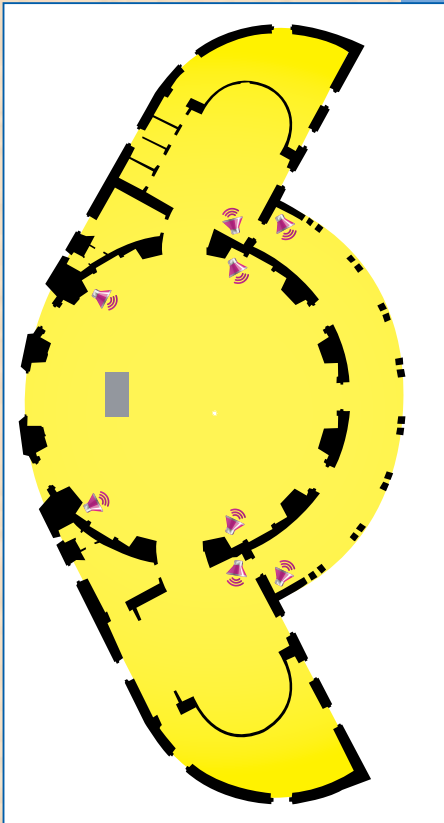

Sanctuary of the Missionary Fathers of the Consoled Church of Kileleshwa - NairoBy - Kenya

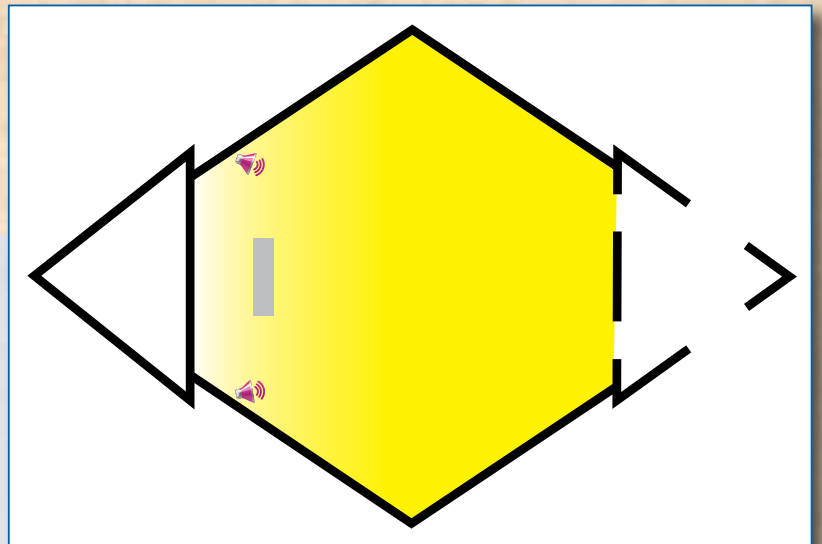

Virgin Mary Parish of Busca - Cuneo

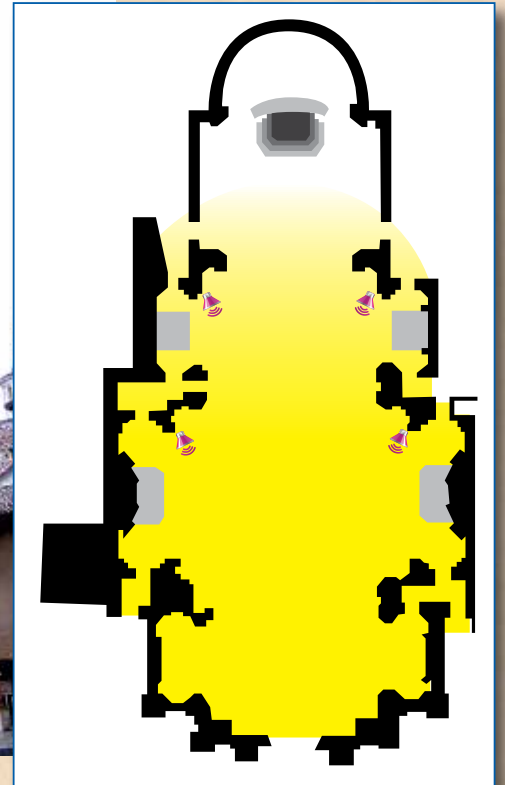

Sanctuary of Our Lady of Oak -Imperia

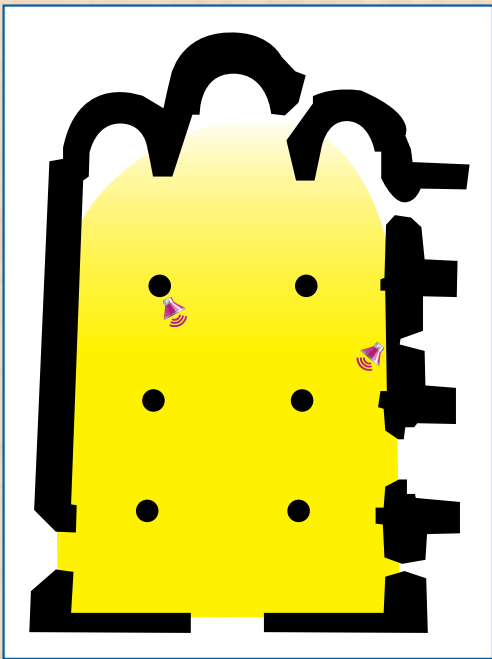

Sanctuary of Madonna del Monte in Marsure (Pn)

The audio system relies on two RAE loudspeakers. The Via Crucis is echoed along the mountain where the Sanctuary stands with a radio bridge system placed on the bell tower.

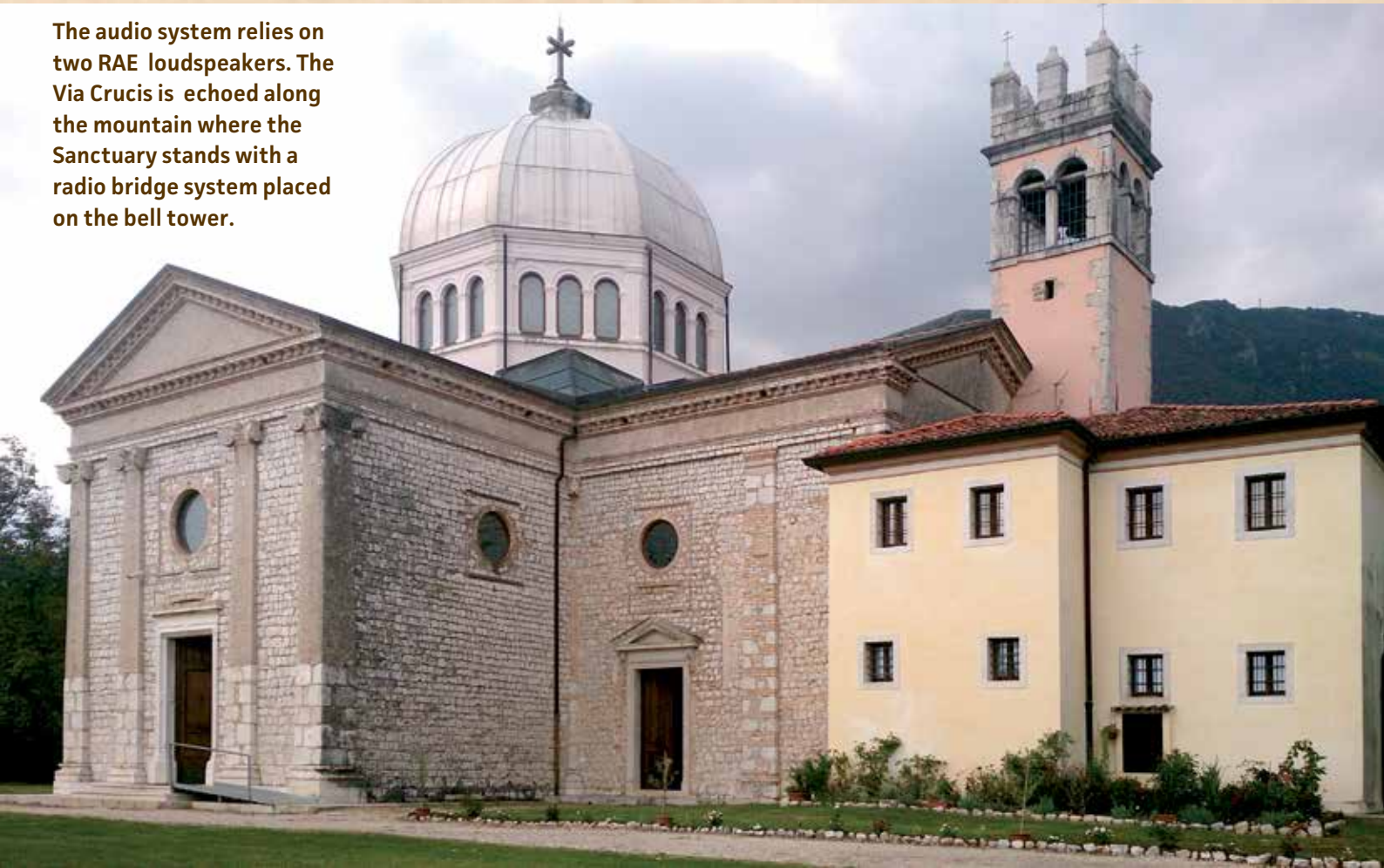

Church of Saints. Peter and Paul - Aprilia - (It)



Parish of St. Biagio - Monza - (Mi)



Directivity

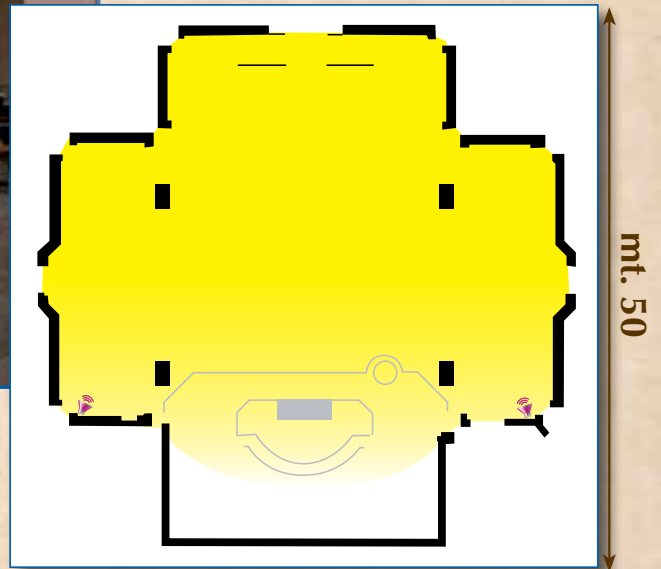

Church of St. Spirito - Perugia

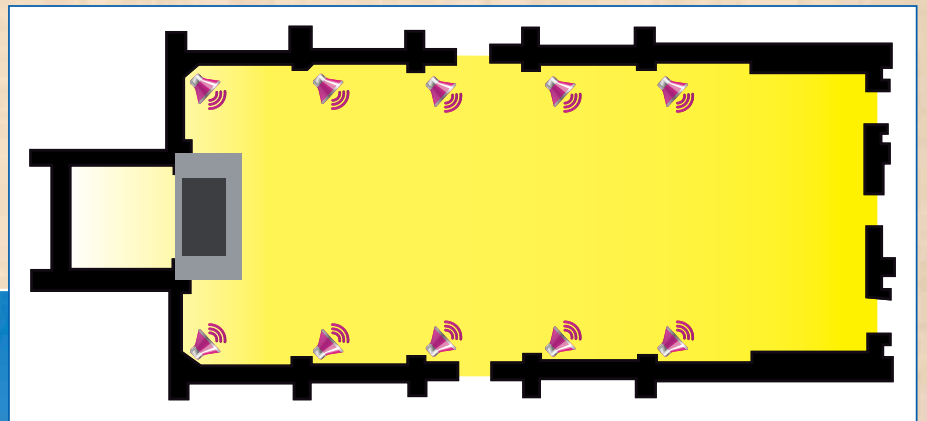

Parish Jean-Paul II a Six Fours les Plages - Tolone

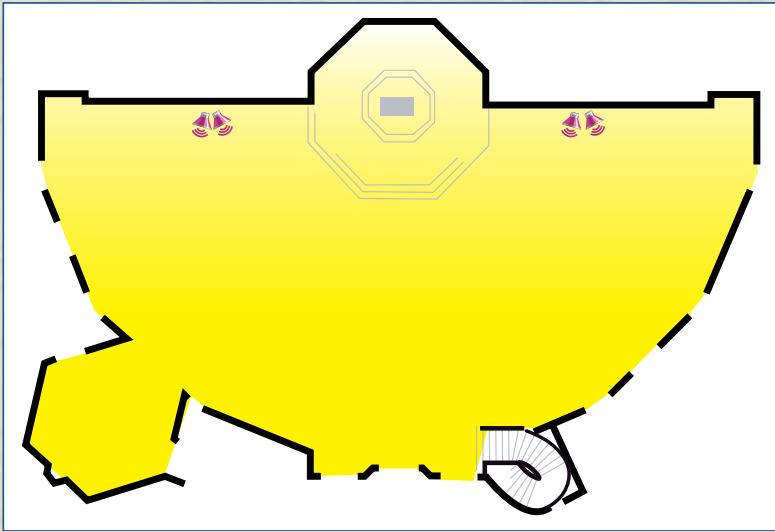

Sanctuary of St. Maria del Pelingo - Acqualagna - Urbino

Complex voice distribution using Fulgor equipment that allows the faithful to listen to high quality audio in multiple areas both inside and outside the sanctuary



Parish of St John the Baptist - Canale of Agordo - (BI)

Belluno is famous for being the birthplace of the Pope Giovanni Paolo I (Pope Albino Luciani).

Passive speaker system from Fulgor Service.

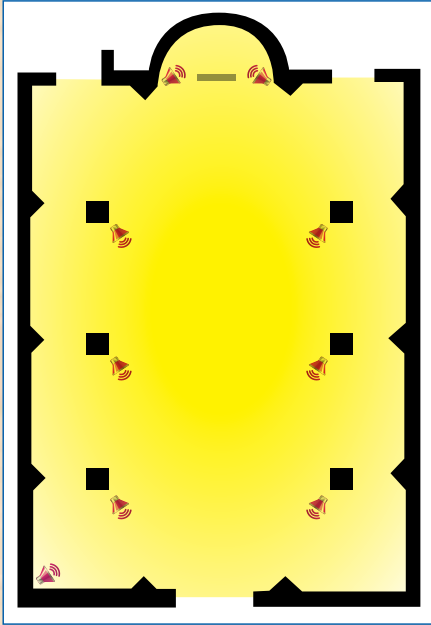

Parish of St. Giovanni Battista Lassalle - Monserrato - (Ca)

Directivity

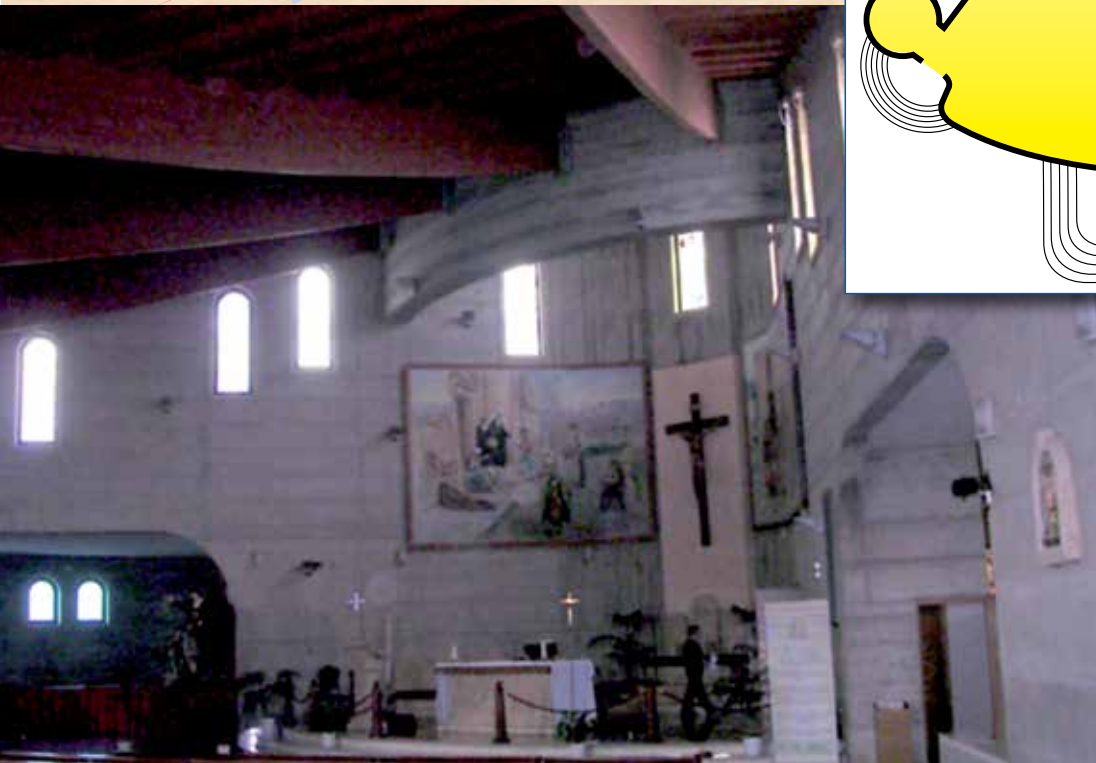
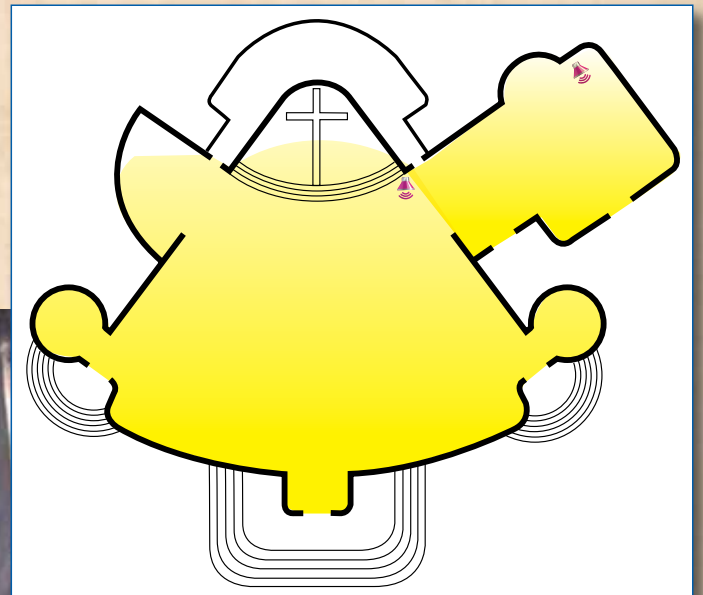

The Triennale of Milan - Design Museum



The audio system consists of several 'Arianna' speakers, battery powered wireless line array speakers that can be positioned anywhere to meet the needs of the occasion.

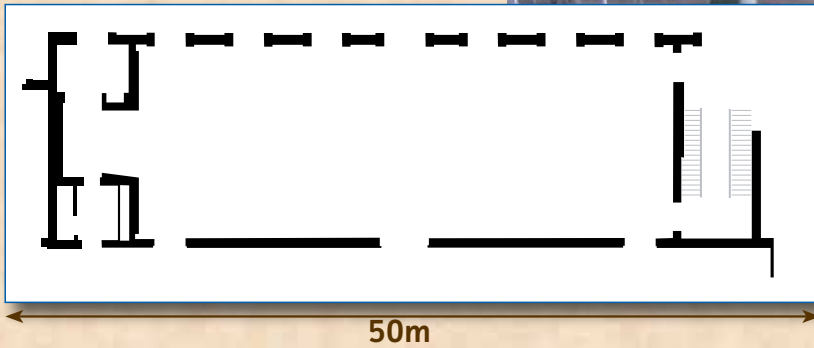

St. Nicola Tolentino Sanctuary - (Mc)

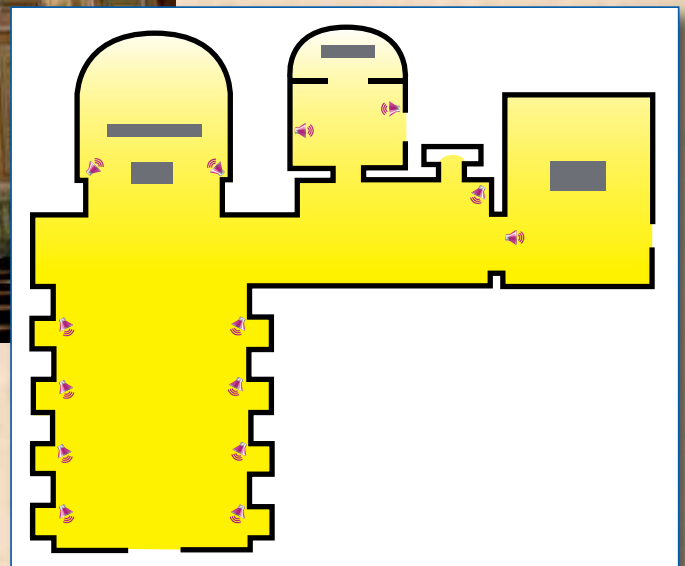

Parish of St. Anna and St Antonio - Benevento



Directivity

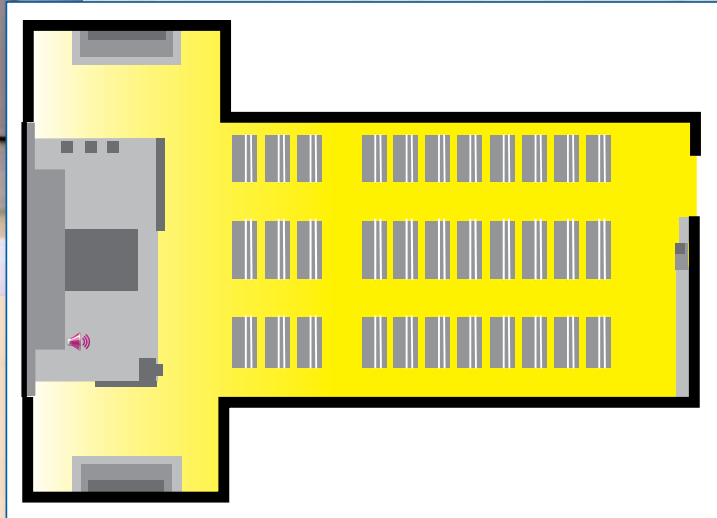

Sanctuary of the Madonna Of Splendor - Giulianova (Te)



ABBey of St Pietro Assisi - (Pg)



Church St Giuseppe - Lagonegro - (Pz)

Directivity

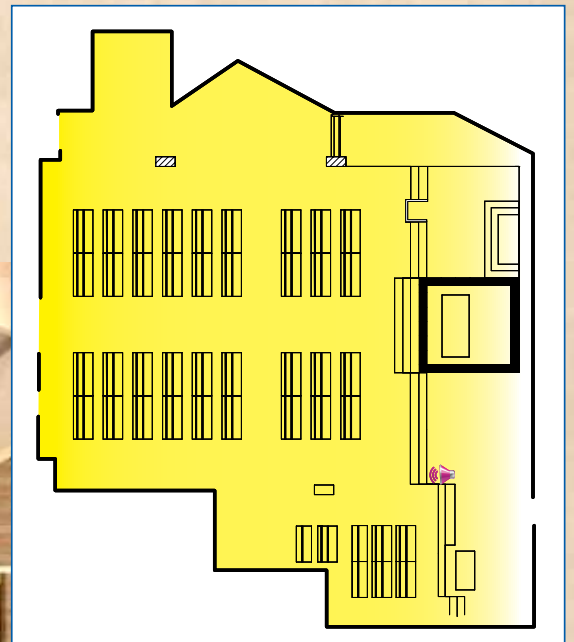

Basilica St. Nicolò - Pietra Ligure - (Sv)



Directivity

55m

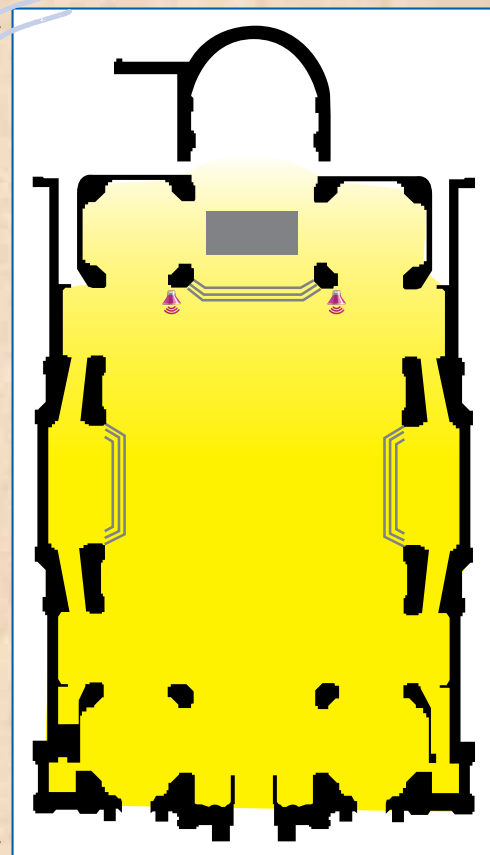

Church of the Madonna - Livorno

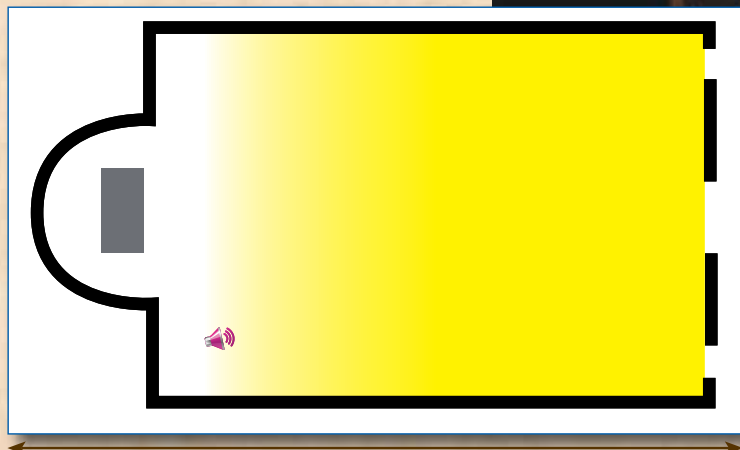

45m

Parish of St Giuseppe - Bari

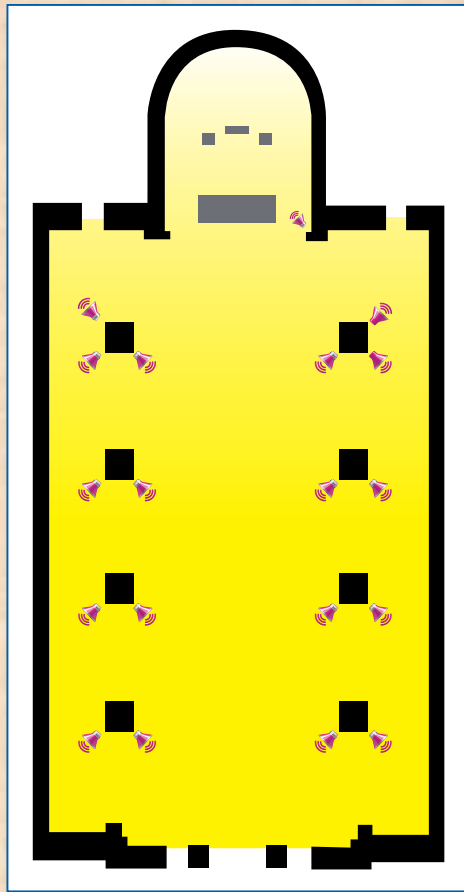

Parish of St Antonio - Bari

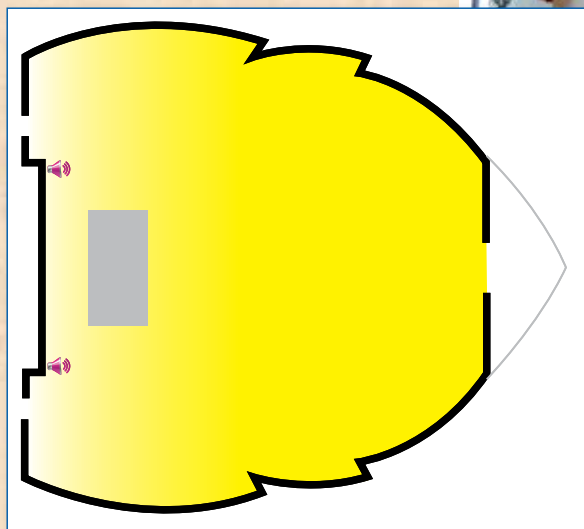

Parish of St Pietro in Palco - Firenze

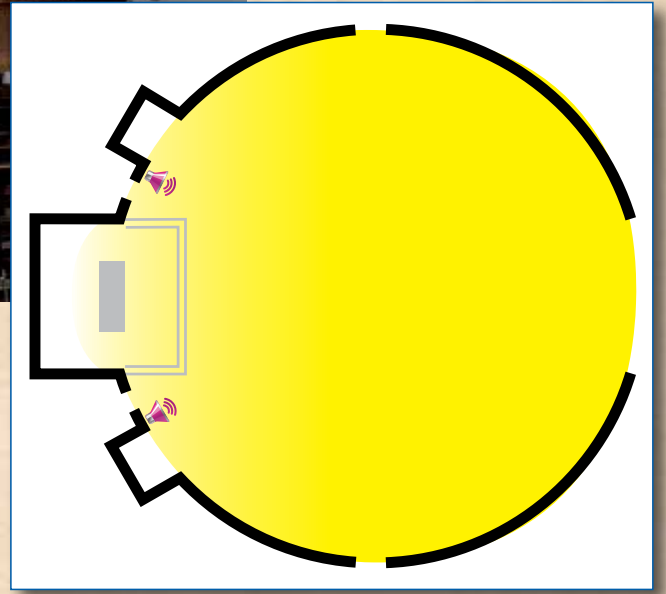

Directivity

mt. 37

Monte Croce Sanctuary - Balestrino - (Im)

The audio management system is centralised,
It manages the sound in two churches the Via Crucis,
the Nativity, the way of the Rosary and the path
outdoors where processions take place
periodically.

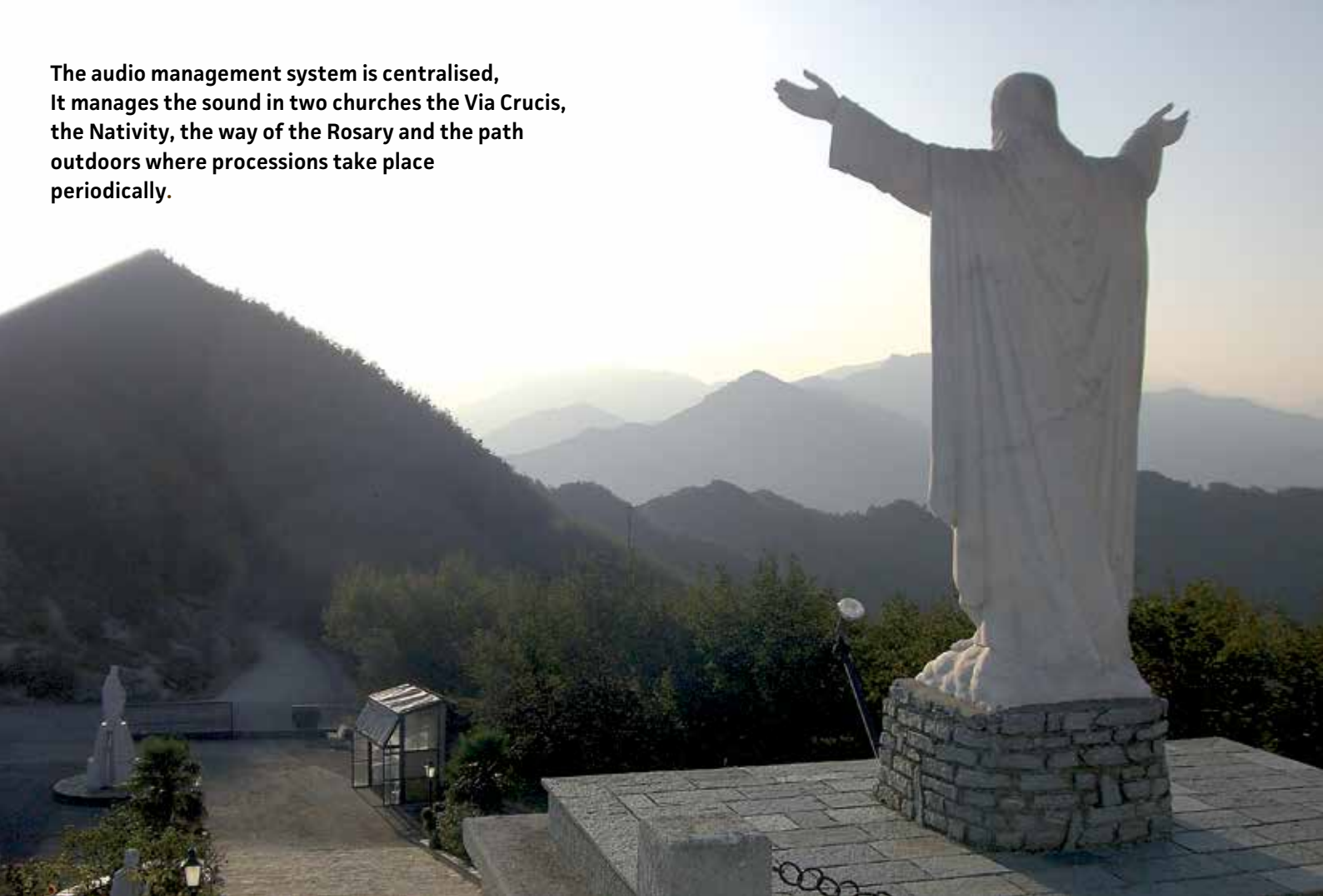



 **univoxaudio**
POWERING INTELLIGIBILITY

01707-339216

www.univoxaudio.co.uk - info@univoxaudio.co.uk



FULGOR SERVICE
SISTEMI DI AMPLIFICAZIONE

Tel. 0187 954488 - Fax 0187 952326
www.fulgorservice.it - info@fulgorservice.it

Numero Verde
800 - 804067

Church of the Transfiguration - Monte Tabor - Galilee